



ΟΡΓΑΝΙΣΜΟΣ
ΒΙΟΜΗΧΑΝΙΚΗΣ
ΙΔΙΟΚΤΗΣΙΑΣ

ΕΙΔΙΚΟ ΔΕΛΤΙΟ
ΒΙΟΜΗΧΑΝΙΚΗΣ
ΙΔΙΟΚΤΗΣΙΑΣ
(ΕΔΒΙ)

ΤΕΥΧΟΣ Β΄
ΣΧΕΔΙΑ ΚΑΙ ΥΠΟΔΕΙΓΜΑΤΑ

ΔΕΚΕΜΒΡΙΟΣ 2008



ΟΡΓΑΝΙΣΜΟΣ
ΒΙΟΜΗΧΑΝΙΚΗΣ
ΙΔΙΟΚΤΗΣΙΑΣ

Παντανάσσης 5
151 25 Παράδεισος Αμαρουσίου

ΤΕΛΕΦΑΞ: 210 6819231

ΤΗΛΕΦΩΝΑ:

ΓΕΝΙΚΕΣ ΠΛΗΡΟΦΟΡΙΕΣ: 210 6183500
ΚΑΤΑΘΕΣΕΙΣ: 210 6183593
ΤΕΛΗ: 210 6183594
ΕΞΕΤΑΣΤΕΣ: 210 6183595
ΛΟΓΙΣΤΗΡΙΟ: 210 6183596
ΝΟΜΙΚΑ ΘΕΜΑΤΑ: 210 6183597
ΤΕΧΝΙΚΗ ΠΛΗΡΟΦΟΡΗΣΗ: 210 6183598
ΔΗΜΟΣΙΕΣ ΣΧΕΣΕΙΣ: 210 6183599

Επιμέλεια - Έκδοση:
Τρόμ Νικόλαος
Οργανισμός Βιομηχανικής Ιδιοκτησίας (OBI)

© Οργανισμός Βιομηχανικής Ιδιοκτησίας (OBI)
02 Φεβρουαρίου 2009



ΟΡΓΑΝΙΣΜΟΣ
ΒΙΟΜΗΧΑΝΙΚΗΣ
ΙΔΙΟΚΤΗΣΙΑΣ

5 Pandanassis Str.
GR 151 25 Paradissos Amaroussiou Athens, Greece

TELEFAX: 210 6819231

TELEPHONS:

GENERAL INFORMATION: 003 210 6183500
RECEIVING OFFICE: 003 210 6183593
FEES: 003 210 6183594
EXAMINERS: 003 210 6183595
ACCOUNTS OFFICE: 003 210 6183596
LEGAL METTERS: 003 210 6183597
TECHNICAL INFORMATION: 003 210 6183598
PUBLIC RELATIONS: 003 210 6183599

Editor - Publisher:
Trom Nicholas
Industrial Property Organisation (OBI)

© Industrial Property Organisation (OBI)
February 02 2009

ΕΙΣΑΓΩΓΙΚΟ ΣΗΜΕΙΩΜΑ

Το Ειδικό Δελτίο Βιομηχανικής Ιδιοκτησίας τηρείται από τον Οργανισμό Βιομηχανικής Ιδιοκτησίας (Ο.Β.Ι.) κατ' εφαρμογή του άρθρου 4 του νόμου 1733/1987 (ΦΕΚ 171,Α') και αποτελείται δύο τεύχη:

Στο **ΤΕΥΧΟΣ Α'** δημοσιεύονται σε μηνιαία βάση τα εξής :

- Αιτήσεις και χορηγήσεις Διπλωμάτων Ευρεσιτεχνίας (Δ.Ε.)
- Αιτήσεις και χορηγήσεις Πιστοποιητικών Υποδείγματος Χρησιμότητας (Π.Υ.Χ.)
- Αιτήσεις και χορηγήσεις Συμπληρωματικών Πιστοποιητικών Προστασίας για Φυτοπροστατευτικά προϊόντα (Σ.Π.Π.Φ.Π.)
- Αιτήσεις και χορηγήσεις Συμπληρωματικών Πιστοποιητικών Προστασίας για Φάρμακα (Σ.Π.Π.Φ.)
- Αιτήσεις Μετάφρασης Αξιώσεων Ευρωπαϊκών Διπλωμάτων Ευρεσιτεχνίας
- Βεβαιώσεις Μεταφράσεων Ευρωπαϊκών Διπλωμάτων Ευρεσιτεχνίας
- Μεταβολές - Διορθώσεις αιτήσεων και χορηγήσεων τίτλων βιομηχανικής ιδιοκτησίας
- Εκπτώσεις - Ανακλήσεις Εκπτώσεων αιτήσεων και χορηγήσεων τίτλων βιομηχανικής ιδιοκτησίας

Στο **ΤΕΥΧΟΣ Β'** δημοσιεύονται σε μηνιαία βάση οι αιτήσεις και τα καταχωρημένα Σχέδια ή Υποδείγματα.

Τα παραπάνω τεύχη διατίθενται ξεχωριστά.

ΔΕΚΕΜΒΡΙΟΣ 2008

Ημερομηνία έκδοσης: 02/02/2009

ΠΕΡΙΕΧΟΜΕΝΑ

	Σελ.
Ανάλυση κωδικών αρθμών.....	5
Συντμήσεις	5

ΜΕΡΟΣ Α΄

ΚΑΤΑΧΩΡΗΜΕΝΕΣ ΑΙΤΗΣΕΙΣ ΣΧΕΔΙΩΝ ΚΑΙ ΥΠΟΔΕΙΓΜΑΤΩΝ

1. Αιτήσεις Σχεδίων και Υποδειγμάτων	7
2. Ευρετήριο αιτήσεων σύμφωνα με την αλφαβητική σειρά των καταθετών	143

ΜΕΡΟΣ Β΄

ΧΟΡΗΓΗΣΕΙΣ ΠΙΣΤΟΠΟΙΗΤΙΚΩΝ ΚΑΤΑΧΩΡΗΣΗΣ ΣΧΕΔΙΩΝ ΚΑΙ ΥΠΟΔΕΙΓΜΑΤΩΝ

1. Πιστοποιητικά καταχώρησης σχεδίων ή υποδειγμάτων.....	145
2. Ευρετήριο πιστοποιητικών καταχώρησης σχεδίων ή υποδειγμάτων σύμφωνα με την αλφαβητική σειρά των καταθετών.....	146

ΜΕΡΟΣ Γ΄

ΑΝΑΝΕΩΣΕΙΣ.....147

ΜΕΡΟΣ Δ΄

ΜΕΤΑΒΟΛΕΣ.....149

ΜΕΡΟΣ Ε΄

ΛΗΞΗ ΠΡΟΣΤΑΣΙΑΣ.....150

ΜΕΡΟΣ ΣΤ΄

ΑΚΥΡΩΣΕΙΣ - ΔΙΟΡΘΩΣΕΙΣ151

– Ανακοινώσεις - Συνδρομές152

DECEMBER 2008

Publication date: 02/02/2009

CONTENTS

	Page
INID Codes	5
Abbreviations	5

PART A΄

REGISTERED DESIGN APPLICATIONS

1. Design Applications	7
2. Design Application Index in alphabetical order of the applicant.	143

PART B΄

GRANTS OF DESIGN REGISTRATION CERTIFICATES

1. Design registration certificates.....	145
2. Index of design registration certificates in alphabetical order of the applicant.....	146

PART C΄

RENEWALS148

PART D΄

MODIFICATIONS149

PART E΄

EXPIRY OF PROTECTION150

PART F΄

ANNULMENTS - CORRECTIONS151

– Announcements - Subscriptions152

ΚΩΔΙΚΟΙ ΑΡΙΘΜΟΙ

- (15) Ημερομηνία καταχώρησης
- (17) Ημερομηνία λήξης 1ης πενταετίας ή ανανέωσης προστασίας σε επόμενη πενταετία
- (21) Αριθμός Αίτησης Σχεδίου ή Υποδείγματος
- (28) Αριθμός Σχεδίων/Υποδειγμάτων
- (30) Συμβατικές Προτεραιότητες
- (45) Ημερομηνία λήξης αναβολής δημοσίευσης
- (51) Διεθνής Ταξινόμηση
- (54) Προσδιορισμός αντικειμένου
- (71) Καταθέτης
- (72) Δημιουργός
- (73) Δικαιούχος
- (74) Πληρεξούσιος
- (74) Αντίκλητος

INID CODES

- (15) Registration date
- (17) Date of expiration of the 1st five-year period, or renewal for further five-year periods
- (21) Design application number
- (28) Number of designs
- (30) Priority
- (45) Date of expiration of deferment
- (51) Class and subclass of the Locarno Classification
- (54) Designation of articles
- (71) Applicant
- (72) Creator
- (73) Owner
- (74) Attorney
- (74) Representative

ΣΥΝΤΜΗΣΕΙΣ

- OBI:** Οργανισμός Βιομηχανικής Ιδιοκτησίας
- EABI:** Ειδικό Δελτίο Βιομηχανικής Ιδιοκτησίας
- Δ.Σ.:** Διοικητικό Συμβούλιο
- ΣΧ. ή ΥΠ.:** Σχέδιο ή Υπόδειγμα
- ΚΑΤ/ΡΗΣΗ:** Καταχώρηση
- ΑΡ.ΑΙΤ.:** Αριθμός αίτησης
- ΑΝΤ/MENΟΥ:** Αντικείμενου

Μ Ε Ρ Ο Σ Α '
ΚΑΤΑΧΩΡΗΜΕΝΕΣ ΑΙΤΗΣΕΙΣ ΣΧΕΔΙΩΝ ΚΑΙ ΥΠΟΔΕΙΓΜΑΤΩΝ

ΑΙΤΗΣΕΙΣ ΣΧΕΔΙΩΝ ΚΑΙ ΥΠΟΔΕΙΓΜΑΤΩΝ

(21) Αρ. Αίτησης Σχ. ή Υπ.: 20080600135

(15) Ημερ. Καταχώρησης: 23/06/2008

(17) Ημ. Λήξης 1ης πενταετίας :23/6/2013

(71) Καταθέτης(ες): ΔΑΣΚΑΛΑΚΗΣ ΚΩΝΣΤΑΝΤΙΝΟΣ
Τύλισος, 71500 ΗΡΑΚΛΕΙΟ (ΗΡΑΚΛΕΙΟΥ),
ΕΛΛΑΔΑ

(30) Συμβ. Προτεραιότητα(ες):

(72) Δημιουργός(οι): ΔΑΣΚΑΛΑΚΗΣ ΚΩΝΣΤΑΝΤΙΝΟΣ

(74) Πληρεξούσιος:

(74) Αντίκλητος:

(28) Αριθμός Σχεδίων/Υποδειγμάτων: 4

(51) Διεθνής Ταξινόμηση: 26-05

(54) Προσδιορισμός Αντικειμένου: ΦΩΤΙΣΤΙΚΑ ΑΠΟ ΣΙΔΕΡΟ, ΠΕΤΡΑ
ΚΑΙ ΓΥΑΛΙ



(21) *Αρ. Αίτησης Σχ. ή Υπ.*: 20080600144

(15) *Ημερ. Καταχώρησης*: 01/07/2008

(17) *Ημ. Λήξης 1ης πενταετίας*: 1/7/2013

(71) *Καταθέτης(ες)*: ΣΥΠΟ Ε.Π.Ε. ΕΤΑΙΡΕΙΑ ΠΕΡΙΟΡΙΣΜΕΝΗΣ
ΕΥΘΥΝΗΣ
Βορείου Ηπείρου 56-58 & Καλλιπόλεως, 10439
ΑΘΗΝΑ (ΑΤΤΙΚΗΣ), ΕΛΛΑΔΑ

(30) *Συμβ. Προτεραιότητα(ες)*:

(72) *Δημιουργός(οι)*: ΣΩΠΑΣΗΣ ΕΜΜΑΝΟΥΗΛ

(74) *Πληρεξούσιος*: ΟΙΚΟΝΟΜΙΔΟΥ ΟΙΚΟΝΟΜΟΥ ΦΩΤΕΙΝΗ
Τυρνίνθου 32, 16561 ΓΛΥΦΑΔΑ (ΑΤΤΙΚΗΣ)

(74) *Αντίκλητος*: ΟΙΚΟΝΟΜΙΔΟΥ ΟΙΚΟΝΟΜΟΥ ΦΩΤΕΙΝΗ
Τυρνίνθου 32, 16561 ΓΛΥΦΑΔΑ (ΑΤΤΙΚΗΣ)

(28) *Αριθμός Σχεδίων/Υποδειγμάτων*: 33

(51) *Διεθνής Ταξινόμηση*: 08-06

(54) *Προσδιορισμός Αντικειμένου*: ΠΟΜΟΛΑ

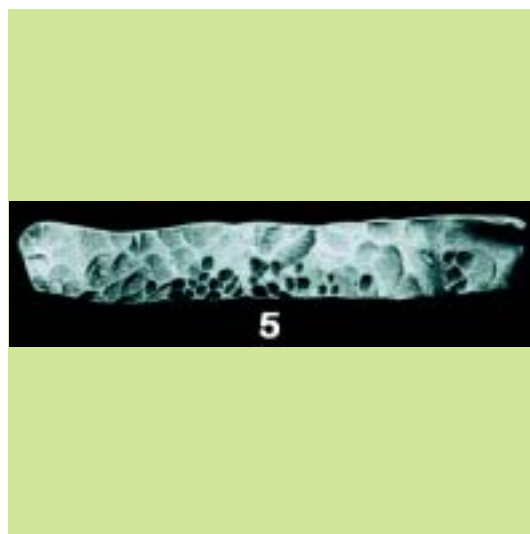
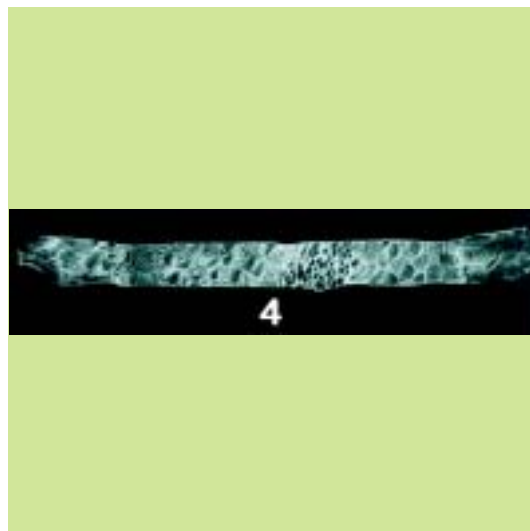
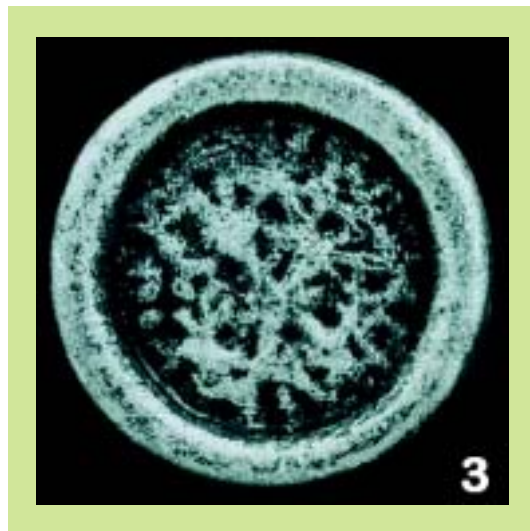

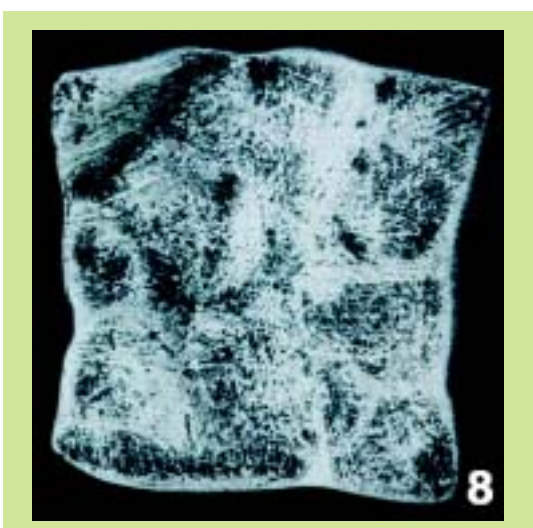
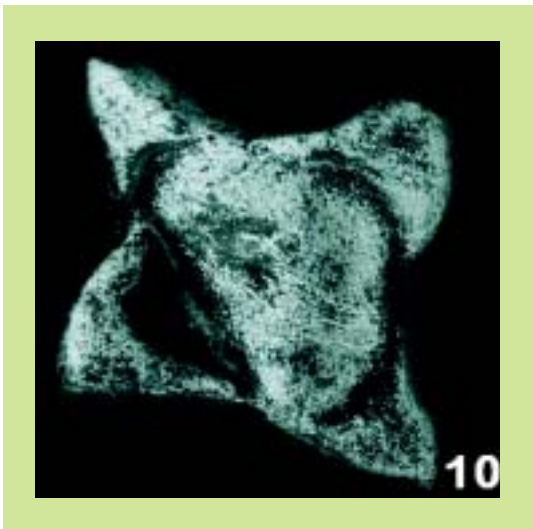
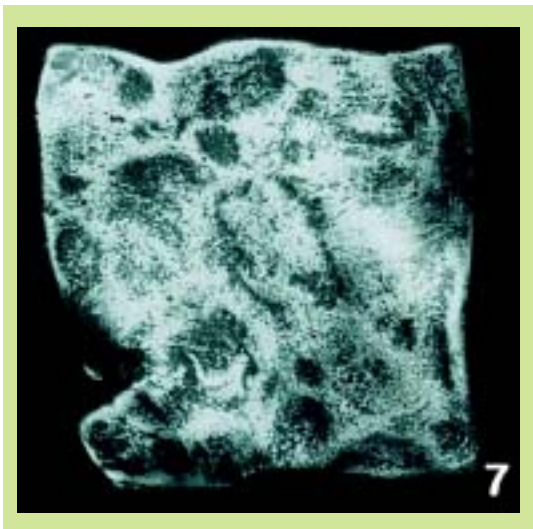
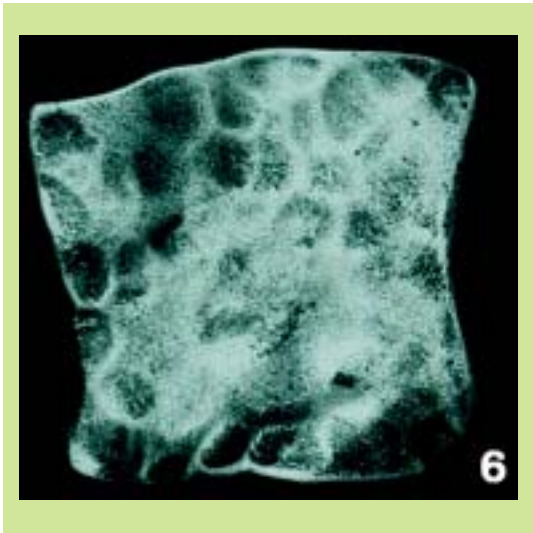

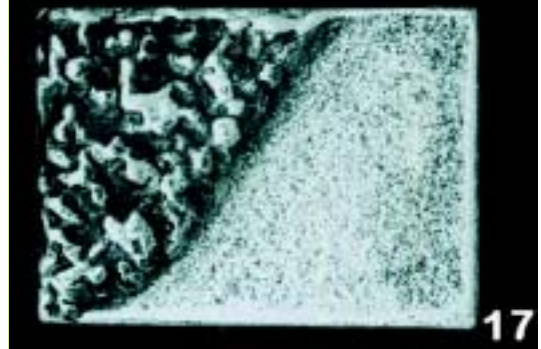
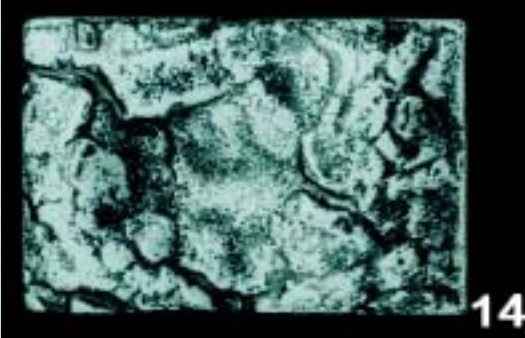
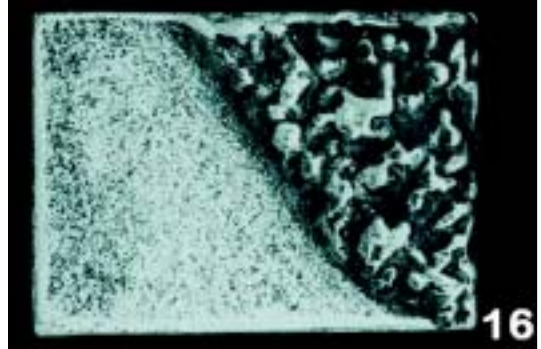
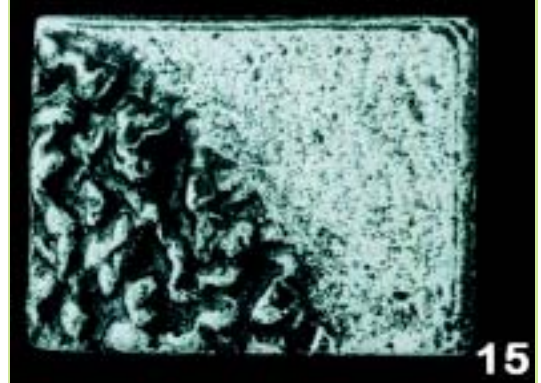
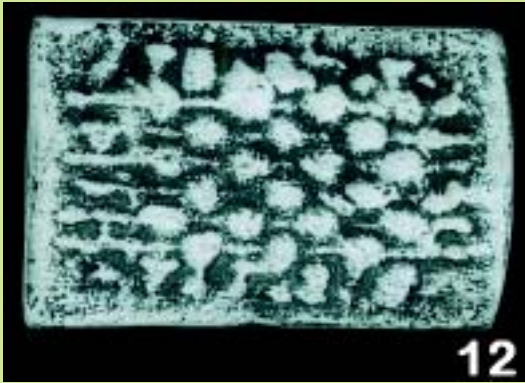

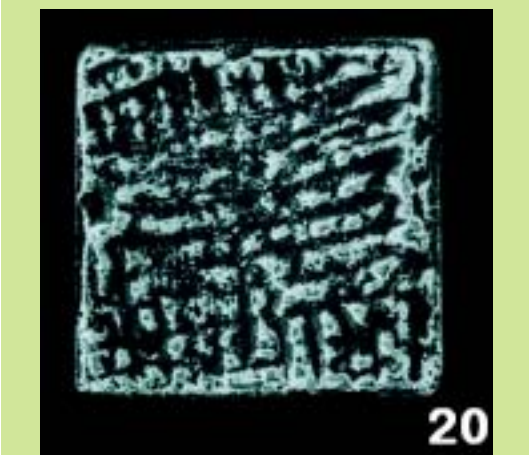
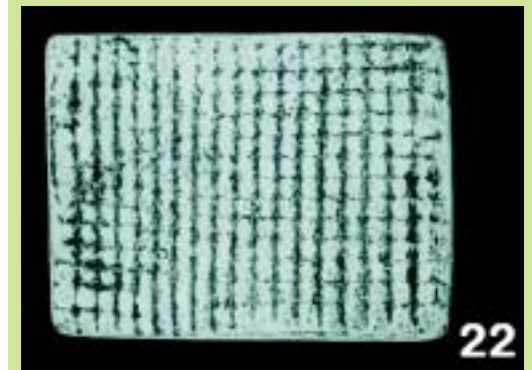

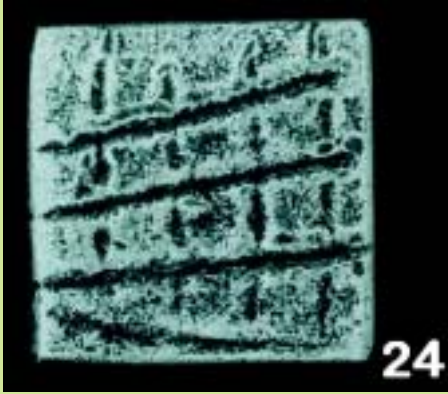

24

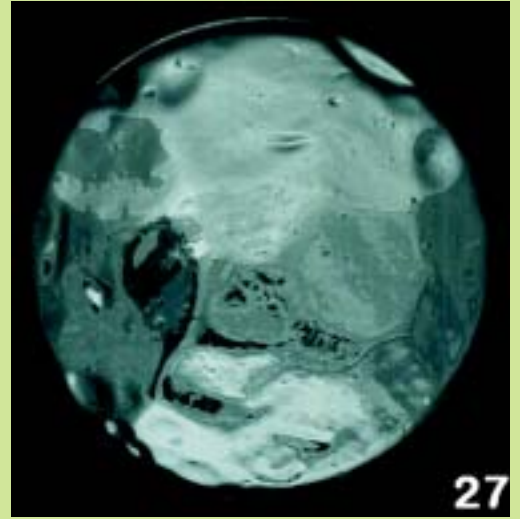

27



25



28



26



29

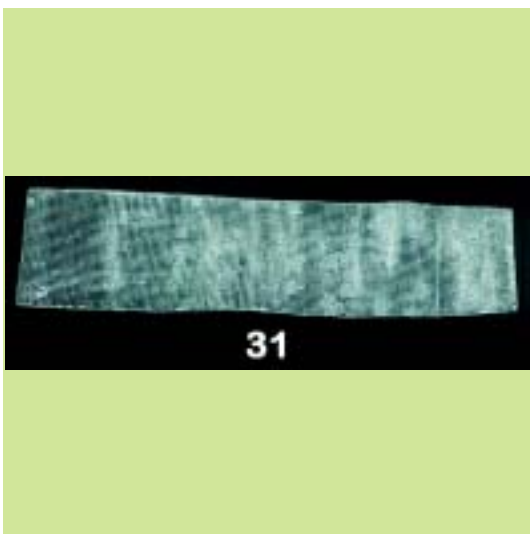
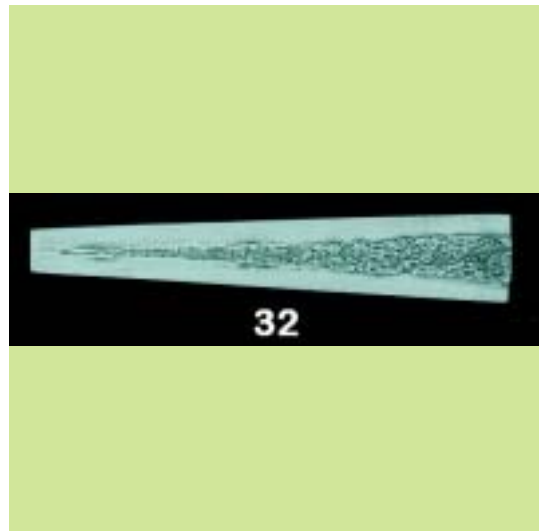
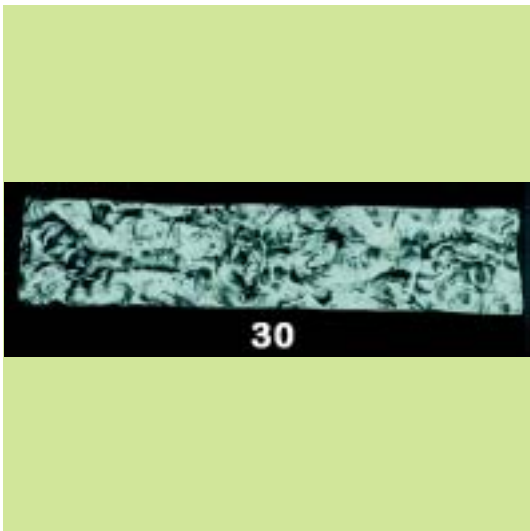

(21) *Αρ. Αίτησης Σχ. ή Υπ.*: 20080600145

(15) *Ημερ. Καταχώρησης*: 01/07/2008

(17) *Ημ. Λήξης 1ης πενταετίας*: 1/7/2013

(71) *Καταθέτης(ες)*: ΜΑΡΚΑΝΤΩΝΑΤΟΥ ΑΝΑΣΤΑΣΙΑ
Ζήτρου 3, 11742 ΑΘΗΝΑ (ΑΤΤΙΚΗΣ), ΕΛΛΑΔΑ

(30) *Συμβ. Προτεραιότητα(ες)*:

(72) *Δημιουργός(οι)*: ΜΑΡΚΑΝΤΩΝΑΤΟΥ ΑΝΑΣΤΑΣΙΑ

(74) *Πληρεξούσιος*: ΠΑΤΣΗΣ ΜΙΧΑΗΛ
Γ.Γενναδίου 1 και Φειδίου 6, 10678 ΑΘΗΝΑ
(ΑΤΤΙΚΗΣ)

(74) *Αντίκλητος*: ΠΑΤΣΗΣ ΜΙΧΑΗΛ
Γ.Γενναδίου 1 και Φειδίου 6, 10678 ΑΘΗΝΑ
(ΑΤΤΙΚΗΣ)

(28) *Αριθμός Σχεδίων/Υποδειγμάτων*: 5

(51) *Διεθνής Ταξινόμηση*: 20-02

(54) *Προσδιορισμός Αντικειμένου*: ΕΚΘΕΤΗΡΙΑ ΚΑΙ ΤΑΜΕΙΑ ΕΜΟΡΙ-
ΚΩΝ ΚΑΤΑΣΤΗΜΑΤΩΝ



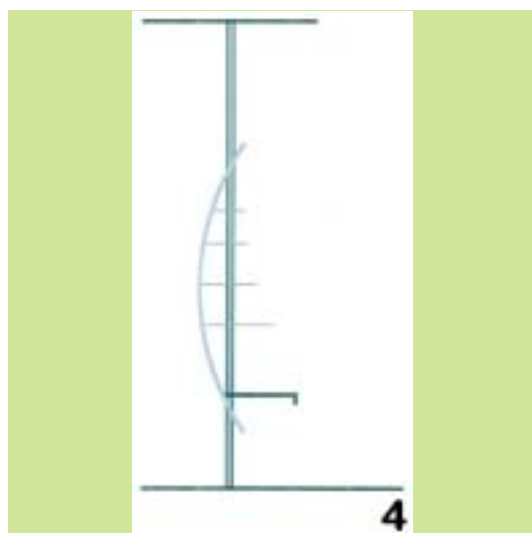
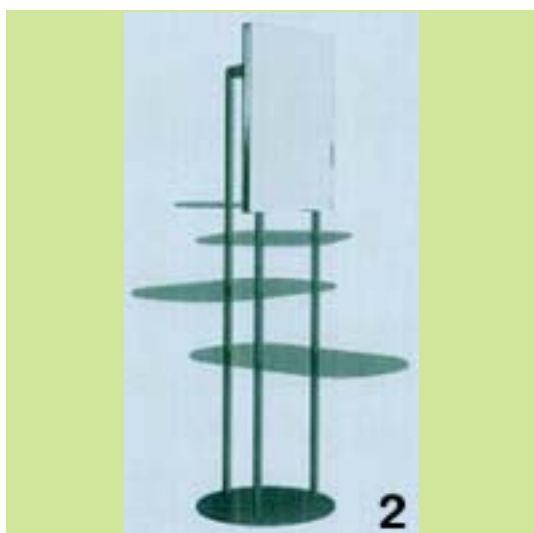

(21) *Αρ. Αίτησης Σχ. ή Υπ.*: 20080600146

(15) *Ημερ.Καταχώρησης*: 01/07/2008

(17) *Ημ. Λήξης 1ης πενταετίας* :1/7/2013

(71) *Καταθέτης(ες)*: ΟΔΥΣΣΕΑΣ ΧΑΤΖΗΒΑΣΙΛΕΙΟΥ ΚΑΙ ΣΙΑ Ε.Ε.
Ιονίας 137, 18450 ΝΙΚΑΙΑ (ΑΤΤΙΚΗΣ),
ΕΛΛΑΔΑ

(30) *Συμβ. Προτεραιότητα(ες)*:

(72) *Δημιουργός(οι)*: ΧΑΤΖΗΒΑΣΙΛΕΙΟΥ ΟΔΥΣΣΕΑΣ

(74) *Πληρεξούσιος*: ΑΝΑΓΝΩΣΤΟΥ ΔΗΜΗΤΡΑ
Λυκαβητού 5, 10672 ΑΘΗΝΑ (ΑΤΤΙΚΗΣ)

(74) *Αντίκλητος*: ΑΝΑΓΝΩΣΤΟΥ ΔΗΜΗΤΡΑ
Λυκαβητού 5,10672 ΑΘΗΝΑ (ΑΤΤΙΚΗΣ)

(28) *Αριθμός Σχεδίων/Υποδειγμάτων*: 50

(51) *Διεθνής Ταξινόμηση*: 10-02

(54) *Προσδιορισμός Αντικειμένου*: ΡΟΛΟΓΙΑ ΧΕΙΡΟΣ



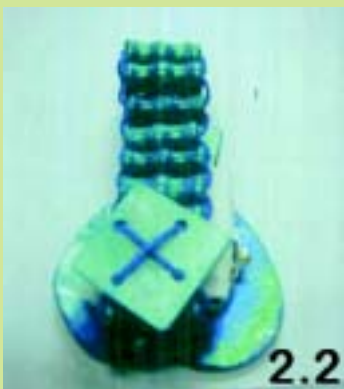
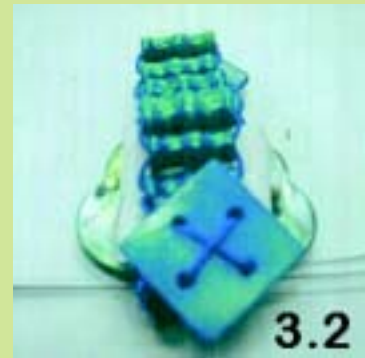



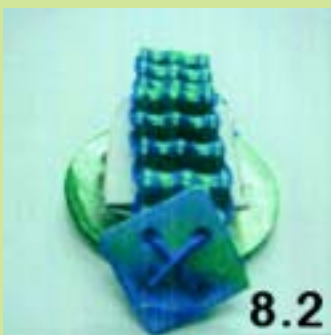



10.2



12.1



11.1



12.2



11.2



13.1



13.2



15.1



14.1

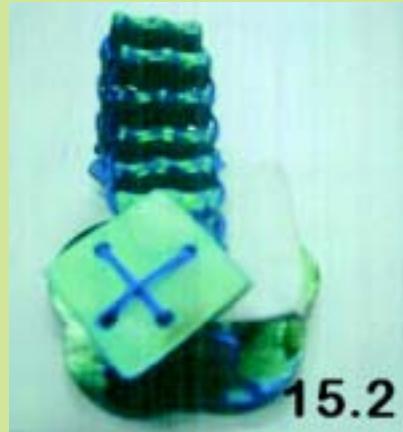

15.2



14.2



16.1

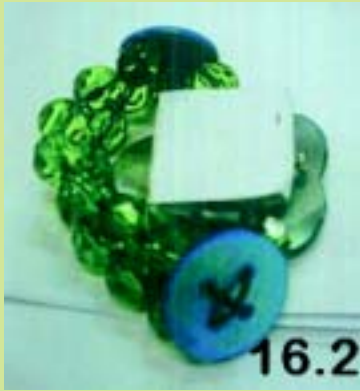

16.2

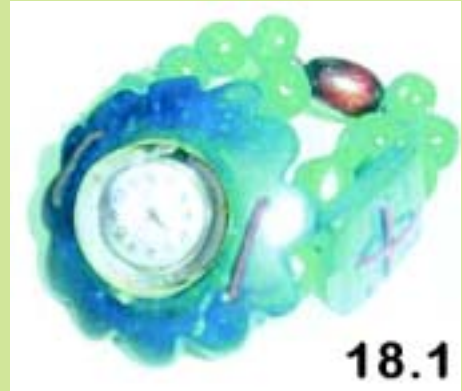

18.1

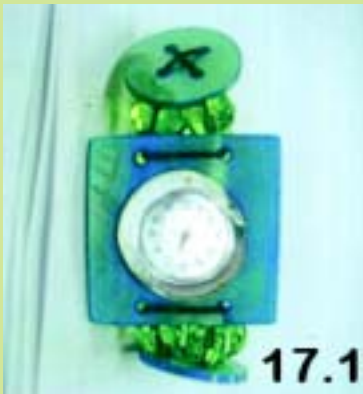

17.1



18.2



17.2



19.1



19.2



21.1

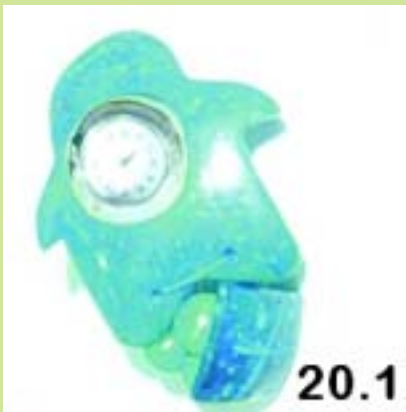

20.1



21.2



20.2



22.1



22.2



24.1



23.1



24.2



23.2



25.1



25.2



27.1



26.1



27.2



26.2



28.1



28.2



30.1



29.1



30.2



29.2

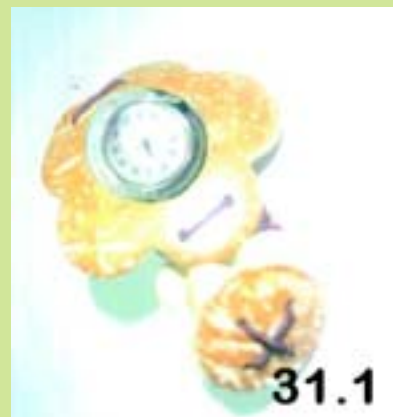

31.1



31.2



33.1



32.1



33.2



32.2



34.1



34.2



36.1



35.1

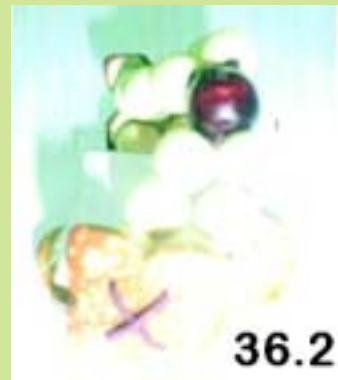

36.2



35.2



37.1



37.2



39.1



38.1



39.2



38.2



40.1



40.2

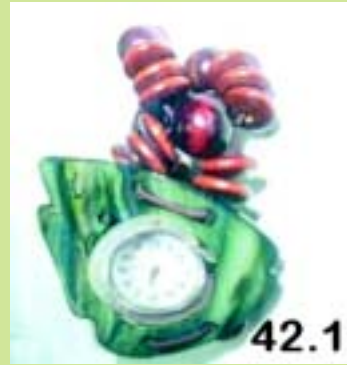

42.1



41.1



42.2



41.2



43.1

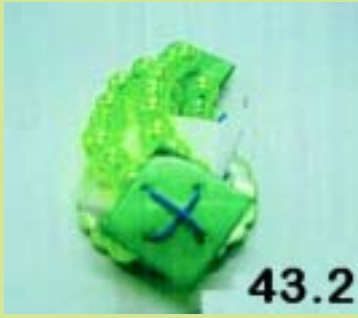

43.2



45.1



44.1

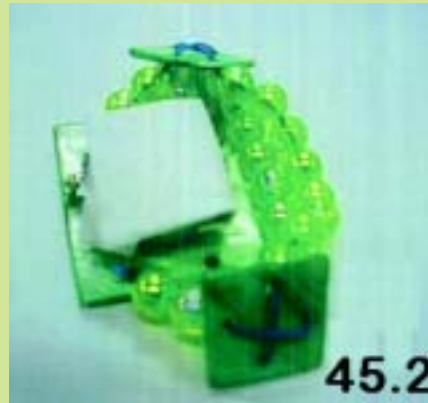

45.2

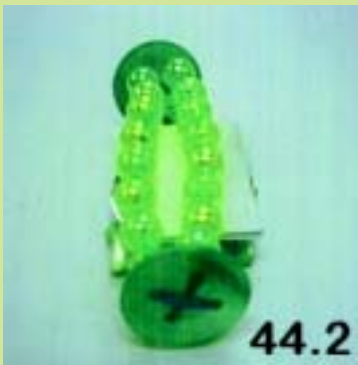

44.2



46.1

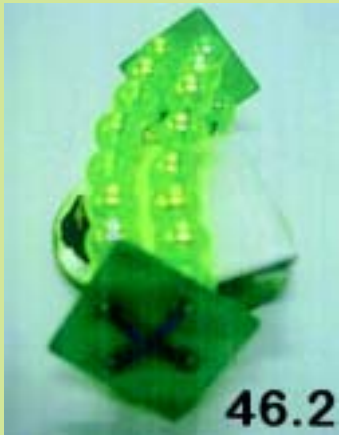

46.2



48.1



47.1

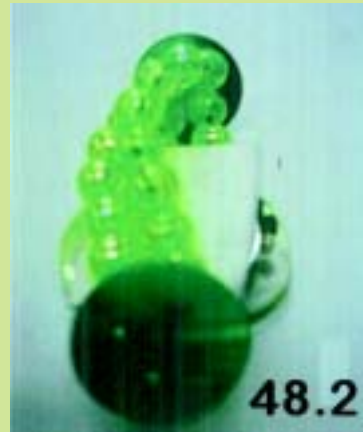

48.2



47.2



49.1

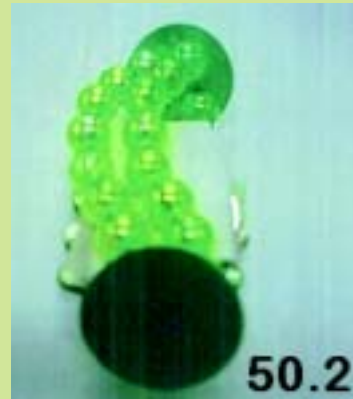
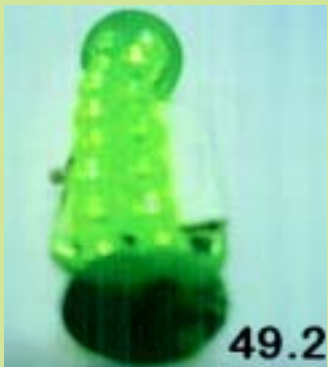

(21) *Αρ. Αίτησης Σχ. ή Υπ.*: 20080600147

(15) *Ημερ. Καταχώρησης*: 01/07/2008

(17) *Ημ. Λήξης 1ης πενταετίας*: 1/7/2013

(71) *Καταθέτης(ες)*: ΟΔΥΣΣΕΑΣ ΧΑΤΖΗΒΑΣΙΛΕΙΟΥ ΚΑΙ ΣΙΑ Ε.Ε.
Ιονίας 137, 18450 ΝΙΚΑΙΑ (ΑΤΤΙΚΗΣ),
ΕΛΛΑΔΑ

(30) *Συμβ. Προτεραιότητα(ες)*:

(72) *Δημιουργός(οι)*: ΧΑΤΖΗΒΑΣΙΛΕΙΟΥ ΟΔΥΣΣΕΑΣ

(74) *Πληρεξούσιος*: ΑΝΑΓΝΩΣΤΟΥ ΔΗΜΗΤΡΑ
Λυκαβητού 5, 10672 ΑΘΗΝΑ (ΑΤΤΙΚΗΣ)

(74) *Αντίκλητος*: ΑΝΑΓΝΩΣΤΟΥ ΔΗΜΗΤΡΑ
Λυκαβητού 5, 10672 ΑΘΗΝΑ (ΑΤΤΙΚΗΣ)

(28) *Αριθμός Σχεδίων/Υποδειγμάτων*: 50

(51) *Διεθνής Ταξινόμηση*: 10-02

(54) *Προσδιορισμός Αντικειμένου*: ΡΟΛΟΓΙΑ ΧΕΙΡΟΣ





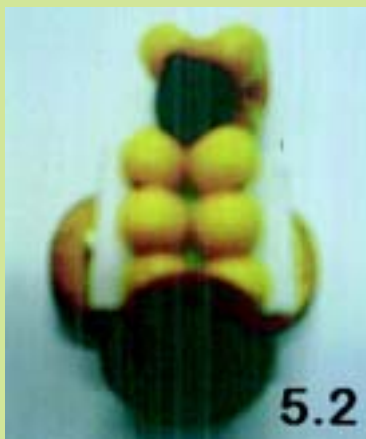



7.2



9.1



8.1



9.2



8.2



10.1



10.2



12.1



11.1



12.2

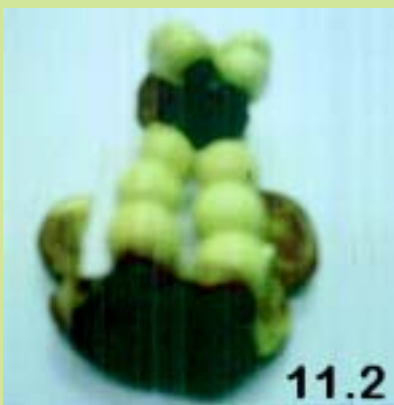

11.2

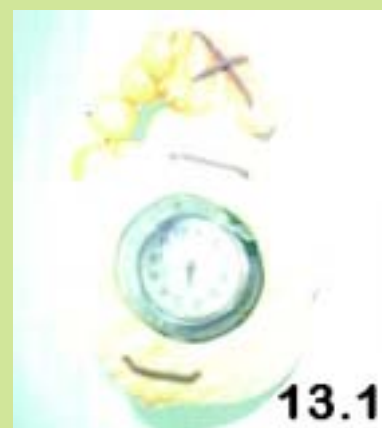

13.1



13.2



15.1



14.1



15.2



14.2



16.1



16.2



18.1



17.1



18.2



17.2



19.1



9.2



21.1



20.1



21.2



20.2



22.1



22.2



24.1



23.1



24.2



23.2



25.1



25.2



27.1



26.1



27.2



26.2



28.1



28.2



30.1



29.1



30.2



9.2



31.1



31.2



33.1



32.1



33.2



32.2



34.1



34.2



36.1



35.1



36.2



35.2



37.1

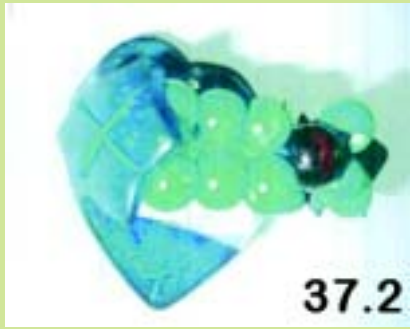

37.2



39.1



38.1



39.2



38.2



40.1



40.2



42.1



41.1



42.2



41.2



43.1



43.2



45.1



44.1



45.2



44.2



46.1





(21) *Αρ. Αίτησης Σχ. ή Υπ.*: 20080600148

(15) *Ημερ. Καταχώρησης*: 02/07/2008

(17) *Ημ. Αήξης 1ης πενταετίας*: 2/7/2013

(71) *Καταθέτης(ες)*: ΟΔΥΣΣΕΑΣ ΧΑΤΖΗΒΑΣΙΛΕΙΟΥ ΚΑΙ ΣΙΑ Ε.Ε.
Ιωνίας 137, 18450 ΝΙΚΑΙΑ (ΑΤΤΙΚΗΣ),
ΕΛΛΑΔΑ

(30) *Συμβ. Προτεραιότητα(ες)*:

(72) *Δημιουργός(οι)*: ΧΑΤΖΗΒΑΣΙΛΕΙΟΥ ΟΔΥΣΣΕΑΣ

(74) *Πληρεξούσιος*: ΑΝΑΓΝΩΣΤΟΥ ΔΗΜΗΤΡΑ
Λυκαβητού 5, 10672 ΑΘΗΝΑ (ΑΤΤΙΚΗΣ)

(74) *Αντίκλητος*: ΑΝΑΓΝΩΣΤΟΥ ΔΗΜΗΤΡΑ
Λυκαβητού 5, 10672 ΑΘΗΝΑ (ΑΤΤΙΚΗΣ)

(28) *Αριθμός Σχεδίων/Υποδειγμάτων*: 50

(51) *Διεθνής Ταξινόμηση*: 10-02

(54) *Προσδιορισμός Αντικειμένου*: ΡΟΛΟΓΙΑ ΧΕΙΡΟΣ





1.2



3.1



2.1



3.2



2.2



4.1



4.2



6.1



5.1



6.2



5.2



7.1



7.2



9.1



8.1



9.2



8.2



10.1



10.2



12.1



11.1



12.2



11.2



13.1



13.2



15.1



14.1



15.2

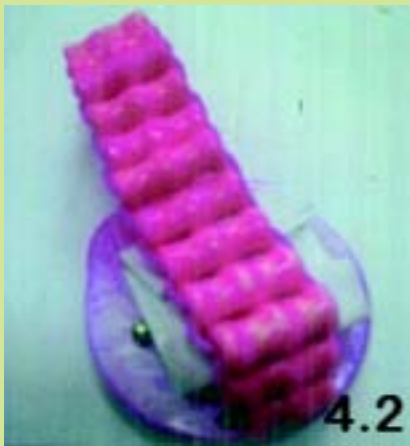

4.2



16.1

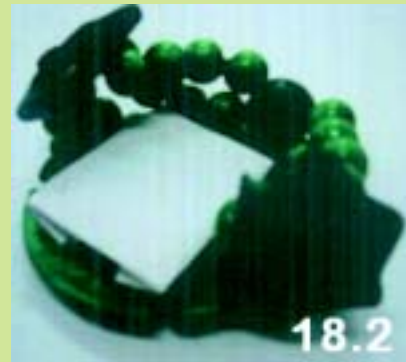



19.2



21.1



20.1



21.2



20.2



22.1

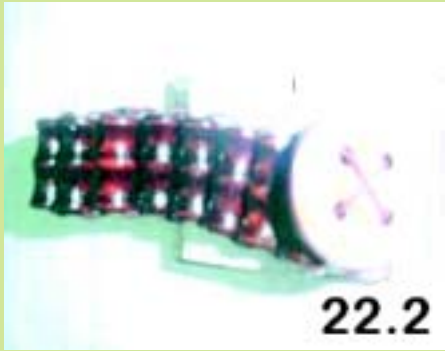

22.2



24.1



23.1



24.2

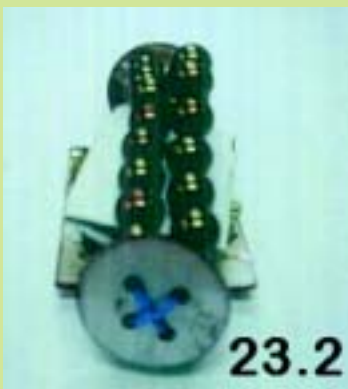

23.2



25.1



25.2

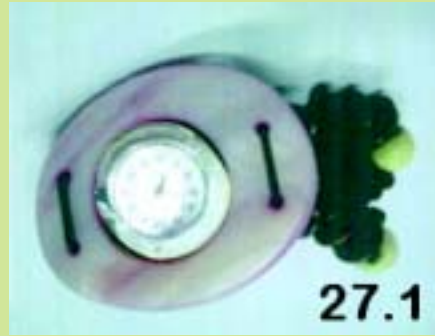

27.1



26.1



27.2



26.2



28.1



28.2



30.1



29.1



30.2



29.2



31.1



31.2

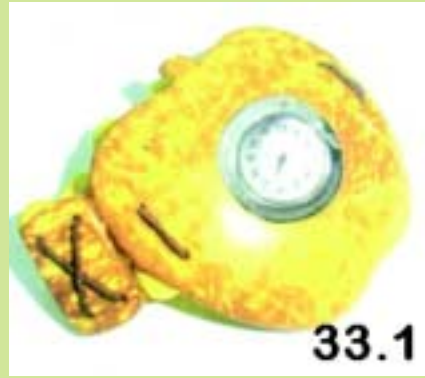

33.1



32.1



33.2



32.2



34.1



34.2

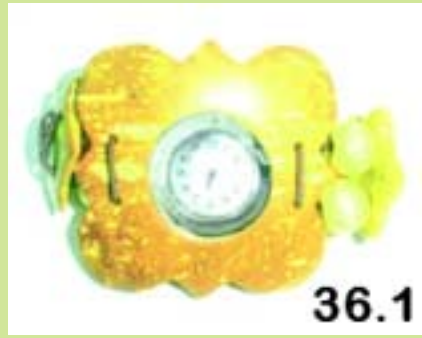

36.1



35.1



36.2



35.2



37.1

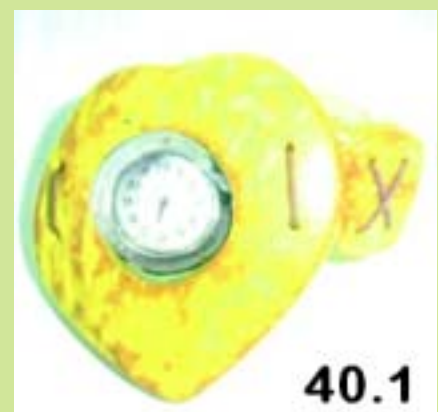





43.2

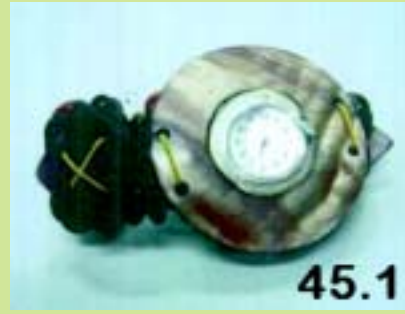

45.1



44.1



45.2



44.2



46.1



46.2



48.1



47.1



48.2



47.2



49.1



(21) Αρ. Αίτησης Σχ. ή Υπ.: 20080600149

(15) Ημερ. Καταχώρησης: 02/07/2008

(17) Ημ. Λήξης 1ης πενταετίας :2/7/2013

(71) Καταθέτης(ες): ΟΔΥΣΣΕΑΣ ΧΑΤΖΗΒΑΣΙΛΕΙΟΥ ΚΑΙ ΣΙΑ Ε.Ε.
Ιωνίας 137, 18450 ΝΙΚΑΙΑ (ΑΤΤΙΚΗΣ),
ΕΛΛΑΔΑ

(30) Συμβ. Προτεραιότητα(ες):

(72) Δημιουργός(οι): ΧΑΤΖΗΒΑΣΙΛΕΙΟΥ ΟΔΥΣΣΕΑΣ

(74) Πληρεξούσιος: ΑΝΑΓΝΩΣΤΟΥ ΔΗΜΗΤΡΑ
Λυκαβητού 5, 10672 ΑΘΗΝΑ (ΑΤΤΙΚΗΣ)

(74) Αντίκλητος: ΑΝΑΓΝΩΣΤΟΥ ΔΗΜΗΤΡΑ
Λυκαβητού 5, 10672 ΑΘΗΝΑ (ΑΤΤΙΚΗΣ)

(28) Αριθμός Σχεδίων/Υποδειγμάτων: 16

(51) Διεθνής Ταξινόμηση: 10-02

(54) Προσδιορισμός Αντικειμένου: ΡΟΛΟΓΙΑ ΧΕΙΡΟΣ



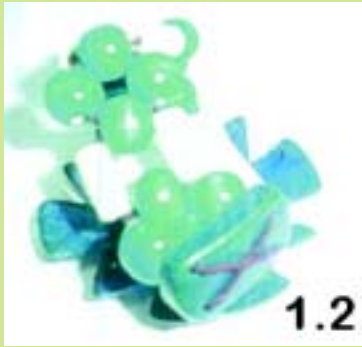

1.2



3.1



2.1



3.2



2.2

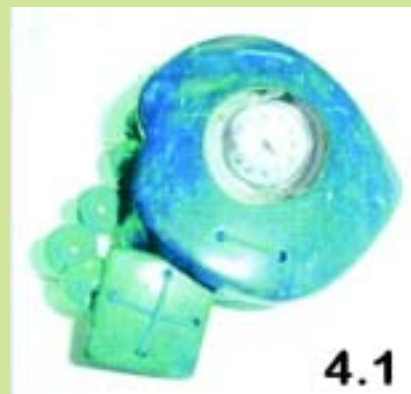

4.1



4.2



6.1



5.1



6.2



5.2



7.1



7.2



9.1



8.1

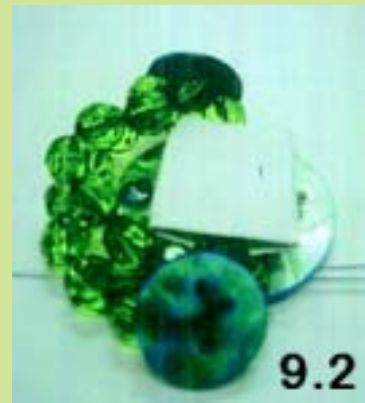

9.2



8.2



10.1



10.2



12.1



11.1



12.2



11.2

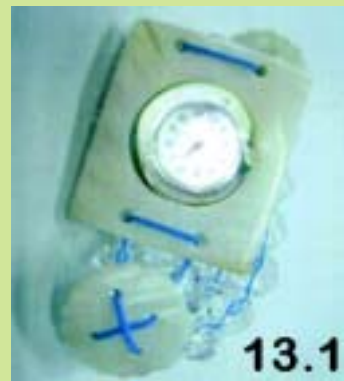

13.1



13.2



15.1



14.1



15.2

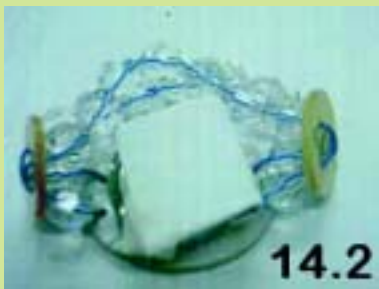

14.2



16.1



(21) Αρ. Αίτησης Σχ. ή Υπ.: 20080600151

(15) Ημερ. Καταχώρησης: 03/07/2008

(17) Ημ. Λήξης 1ης πενταετίας :3/7/2013

(71) Καταθέτης(ες): ΑΝΤΩΝΙΟΥ ΟΔΥΣΣΕΑΣ
 Νοταρά 9, 10683 ΑΘΗΝΑ (ΑΤΤΙΚΗΣ), ΕΛΛΑΔΑ

(30) Συμβ. Προτεραιότητα(ες):

(72) Δημιουργός(οι): ΑΝΤΩΝΙΟΥ ΟΔΥΣΣΕΑΣ

(74) Πληρεξούσιος:

(74) Αντίκλητος: ΑΝΤΩΝΙΟΥ ΜΑΡΙΑ-ΕΛΕΝΗ
 Δελφών 6, Αγία Παρασκευή, 15343 ΑΓΙΑ
 ΠΑΡΑΣΚΕΥΗ (ΑΤΤΙΚΗΣ)

(28) Αριθμός Σχεδίων/Υποδειγμάτων: 15

(51) Διεθνής Ταξινόμηση: 09-05

(54) Προσδιορισμός Αντικειμένου: ΣΑΚΟΥΛΕΣ ΚΑΙ ΣΑΚΟΙ ΣΥΣΚΕΥΑΣΙΑΣ ΚΑΙ ΑΠΟΡΡΙΜΜΑΤΩΝ

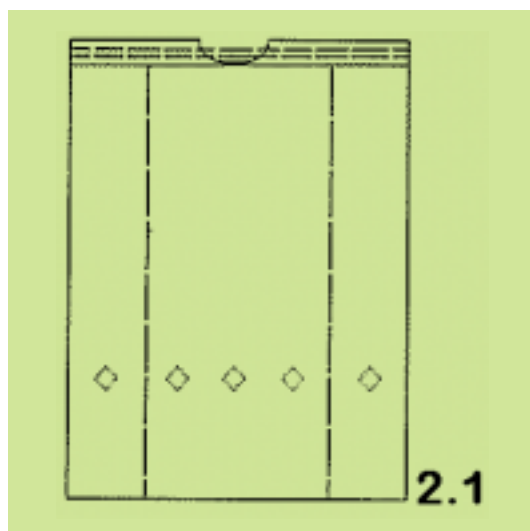
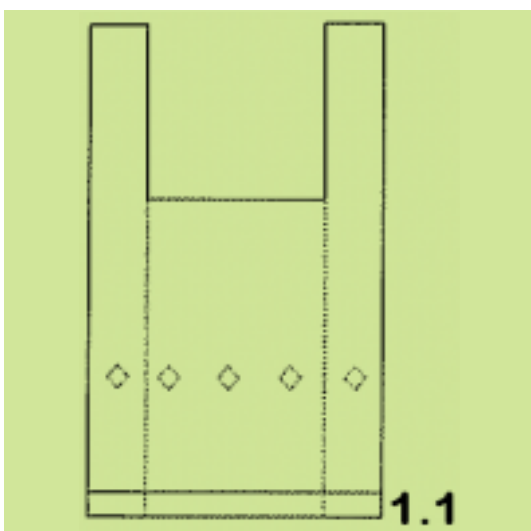
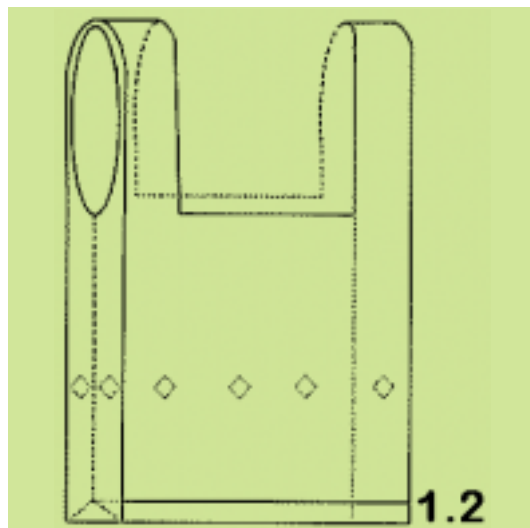

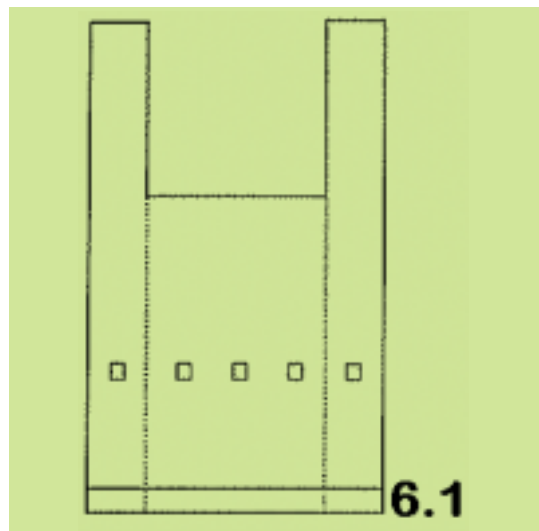
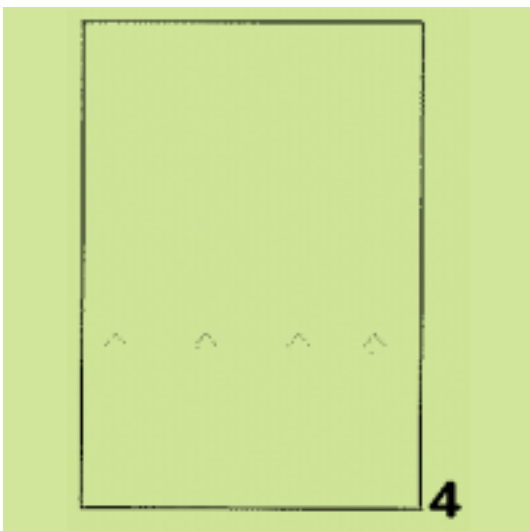
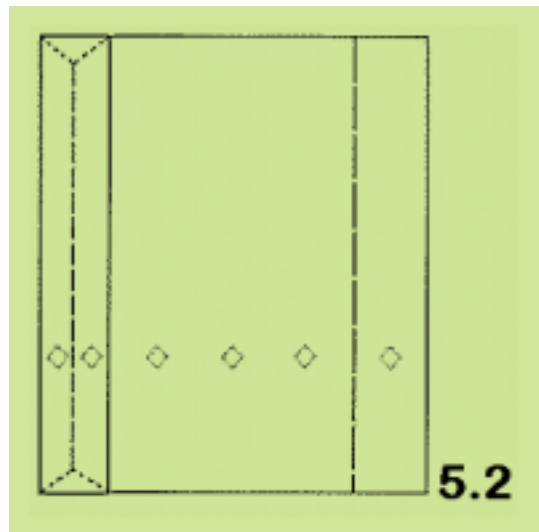
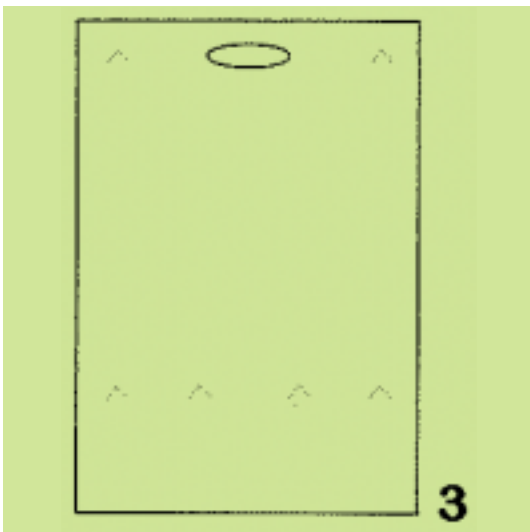
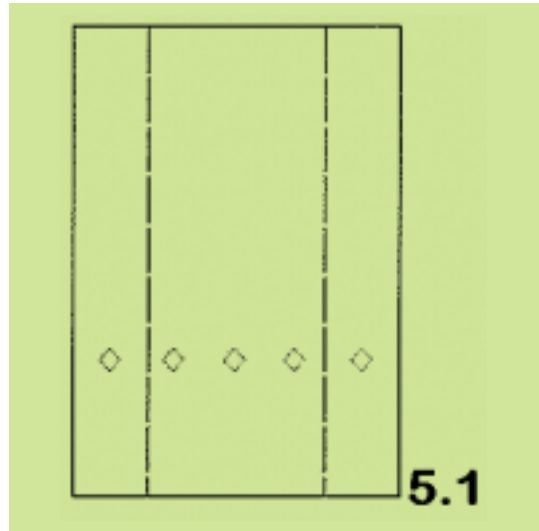
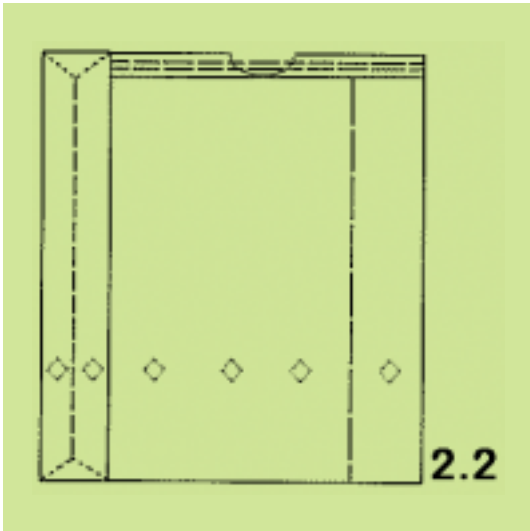

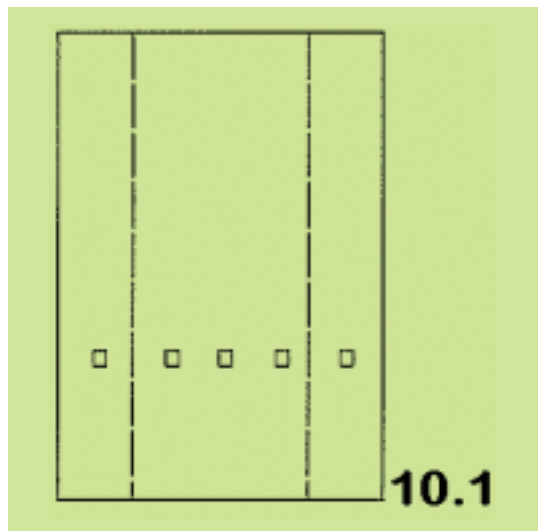
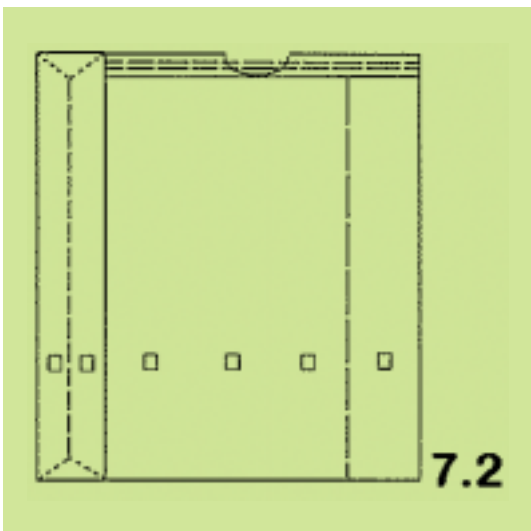
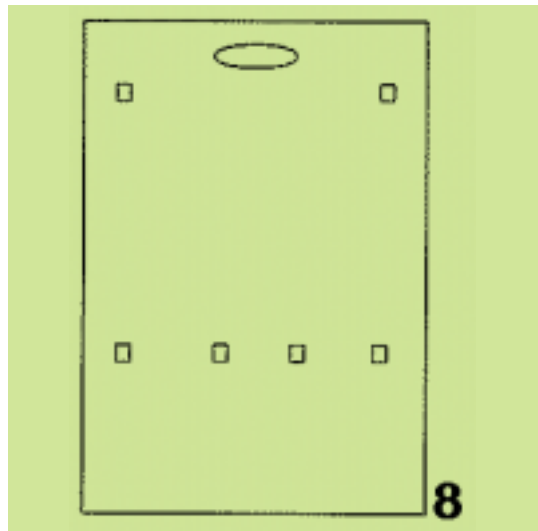
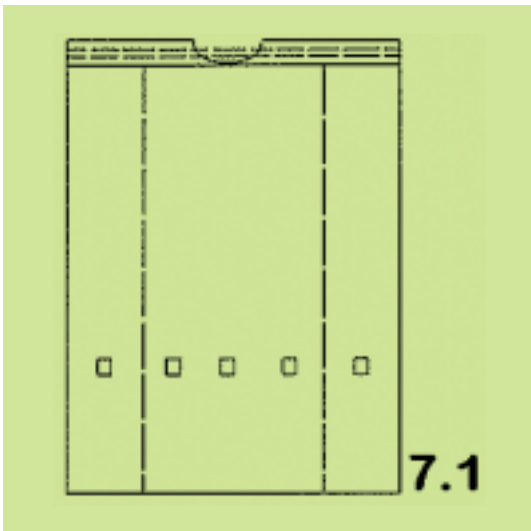
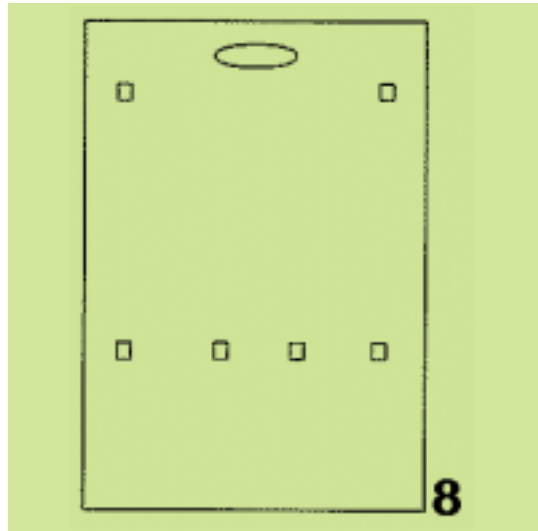
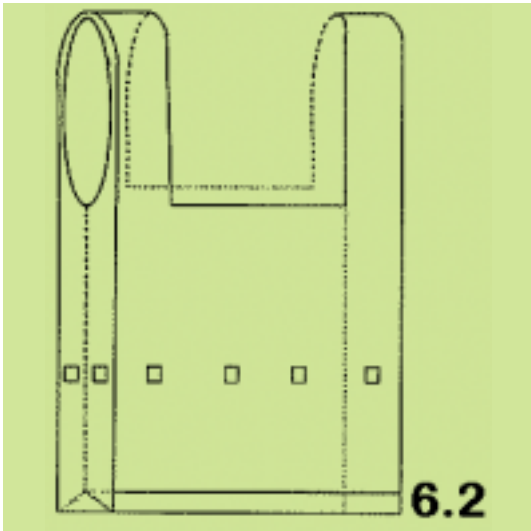

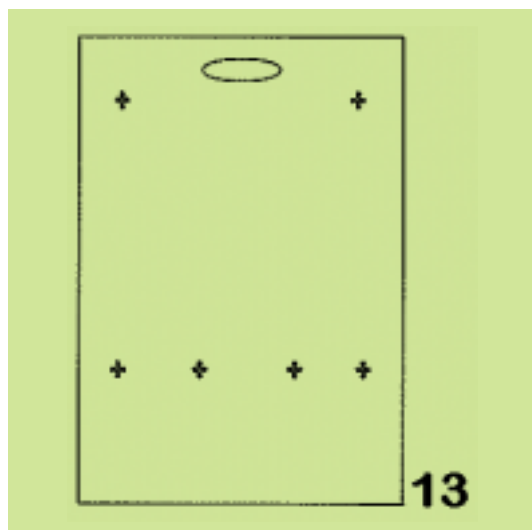
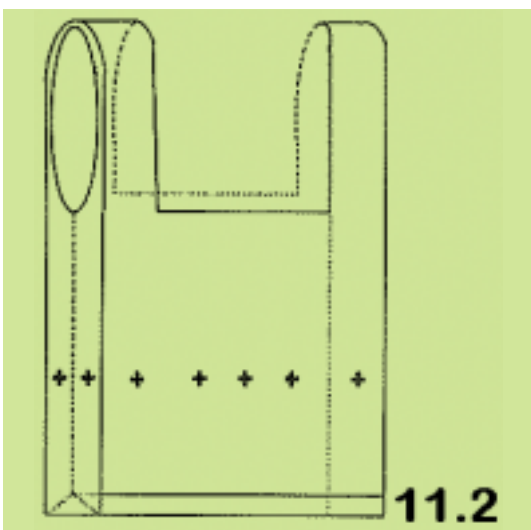
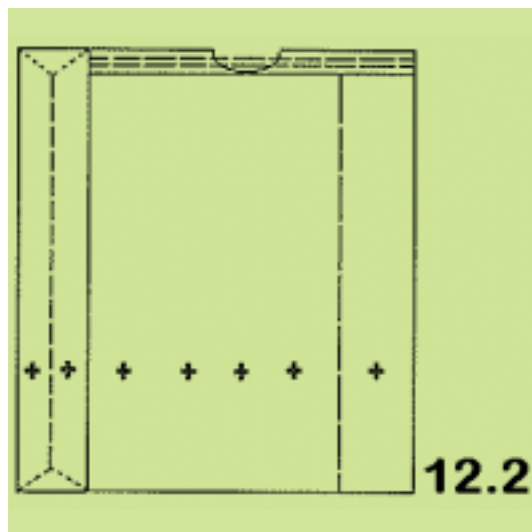
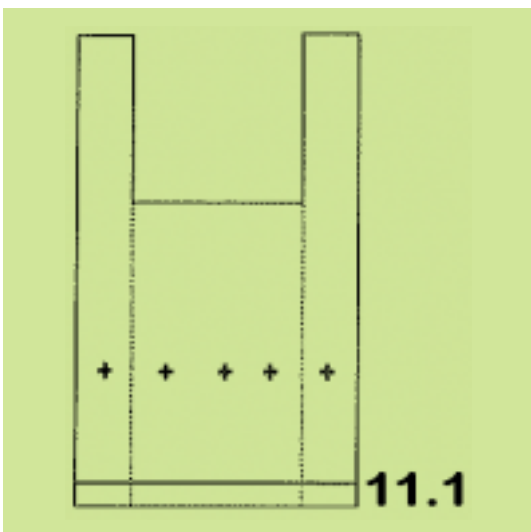
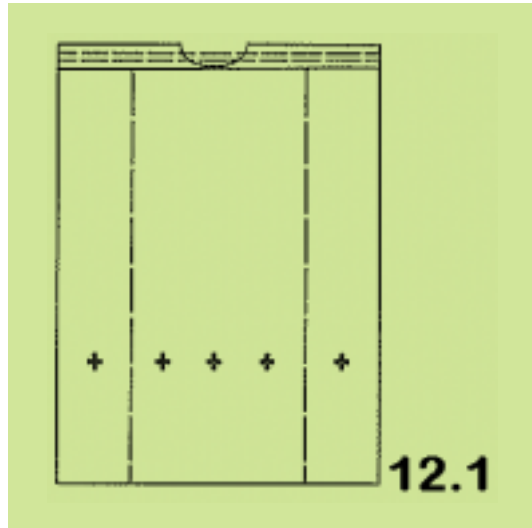
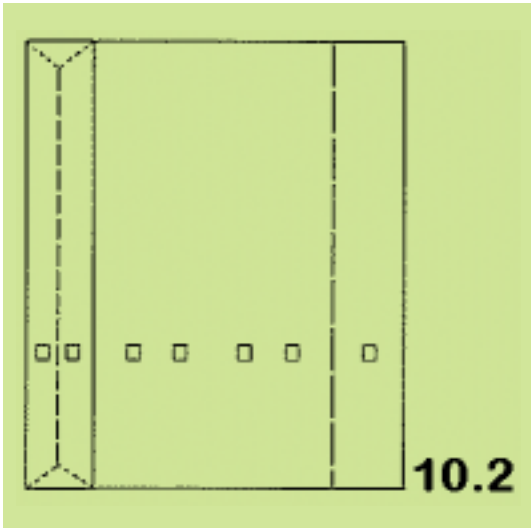

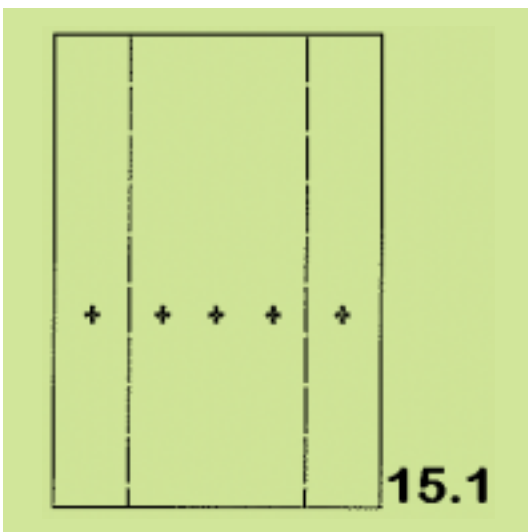
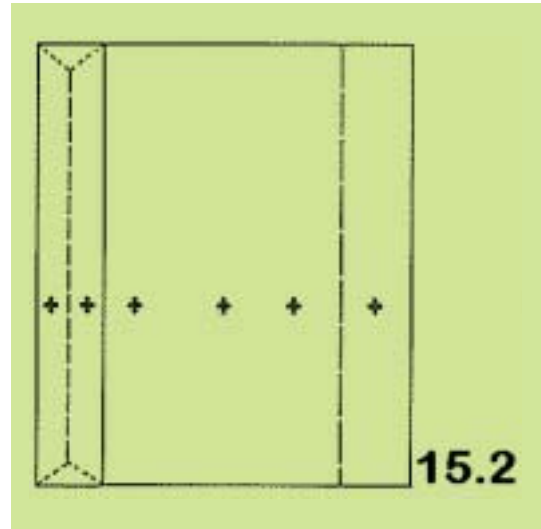
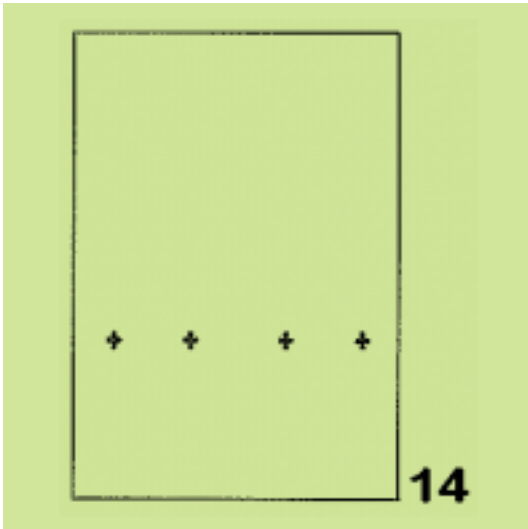

(21) *Αρ. Αίτησης Σχ. ή Υπ.*: 20080600152

(15) *Ημερ. Καταχώρησης*: 01/07/2008

(17) *Ημ. Αήξης 1ης πενταετίας*: 1/7/2013

(71) *Καταθέτης(ες)*: MONITOR ΗΛΕΚΤΡΟΝΙΚΗ ΕΠΕ
Λ. Βουλιαγμένης 403,, 16346 ΗΛΙΟΥΠΟΛΗ
(ΑΤΤΙΚΗΣ), ΕΛΛΑΔΑ

(30) *Συμβ. Προτεραιότητα(ες)*:

(72) *Δημιουργός(οι)*: 1)ΒΑΣΙΛΟΠΟΥΛΟΣ ΘΕΜΙΣΤΟΚΛΗΣ
2)ΓΡΥΠΑΡΗΣ ΒΑΣΙΛΗΣ

(74) *Πληρεξούσιος*:

(74) *Αντικλητος*:

(28) *Αριθμός Σχεδίων/Υποδειγμάτων*: 1

(51) *Διεθνής Ταξινόμηση*: 20-03

(54) *Προσδιορισμός Αντικειμένου*: ΗΛΕΚΤΡΟΝΙΚΟΣ ΣΤΑΥΡΟΣ ΦΑΡ-
ΜΑΚΕΙΟΥ



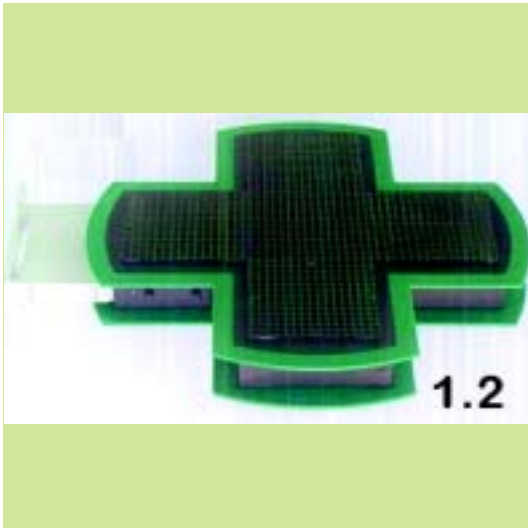

(21) *Αρ. Αίτησης Σχ. ή Υπ.*: 20080600153

(15) *Ημερ. Καταχώρησης*: 04/07/2008

(17) *Ημ. Λήξης 1ης πενταετίας*: 4/7/2013

(71) *Καταθέτης(ες)*: ΓΥΡΙΧΙΔΗΣ ΓΕΩΡΓΙΟΥ ΠΑΝΑΓΙΩΤΗΣ
Βίγλας 4,, 13671 ΑΧΑΡΝΕΣ (ΑΤΤΙΚΗΣ),
ΕΛΛΑΔΑ

(30) *Συμβ. Προτεραιότητα(ες)*:

(72) *Δημιουργός(οι)*: ΓΥΡΙΧΙΔΗΣ ΓΕΩΡΓΙΟΥ ΠΑΝΑΓΙΩΤΗΣ

(74) *Πληρεξούσιος*:

(74) *Αντίκλητος*:

(28) *Αριθμός Σχεδίων/Υποδειγμάτων*: 1

(51) *Διεθνής Ταξινόμηση*: 19-01

(54) *Προσδιορισμός Αντικειμένου*: ΦΑΚΕΛΟΣ ΑΛΛΗΛΟΓΡΑΦΙΑΣ ΜΕ
ΑΠΕΙΚΟΝΙΣΗ



(21) Αρ. Αίτησης Σχ. ή Υπ.: 20080600154

(15) Ημερ. Καταχώρησης: 04/07/2008

(17) Ημ. Λήξης 1ης πενταετίας :4/7/2013

(71) Καταθέτης(ες): ΓΥΡΙΧΙΔΗΣ ΓΕΩΡΓΙΟΥ ΠΑΝΑΓΙΩΤΗΣ
Βίγλας 4, 13671 ΑΧΑΡΝΕΣ (ΑΤΤΙΚΗΣ),
ΕΛΛΑΔΑ

(30) Συμβ. Προτεραιότητα(ες):

(72) Δημιουργός(οι): ΓΥΡΙΧΙΔΗΣ ΓΕΩΡΓΙΟΥ ΠΑΝΑΓΙΩΤΗΣ

(74) Πληρεξούσιος:

(74) Αντίκλητος:

(28) Αριθμός Σχεδίων/Υποδειγμάτων: 1

(51) Διεθνής Ταξινόμηση: 19-01

(54) Προσδιορισμός Αντικειμένου: ΧΑΡΤΙ ΜΙΑΙΜΕΤΡΕ

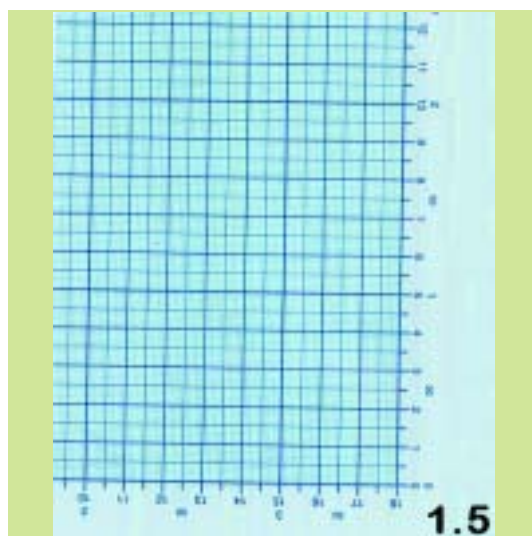
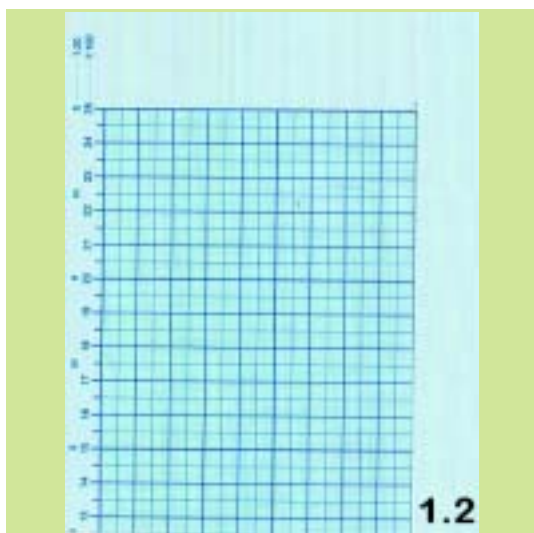
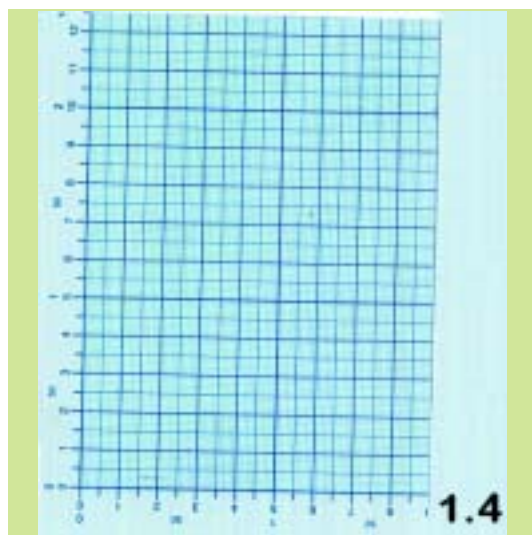
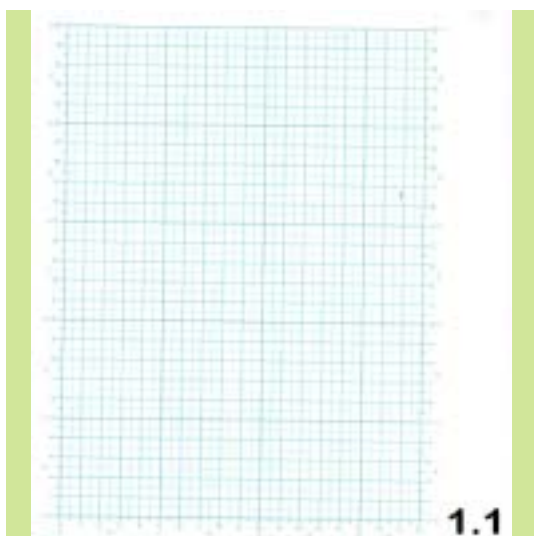
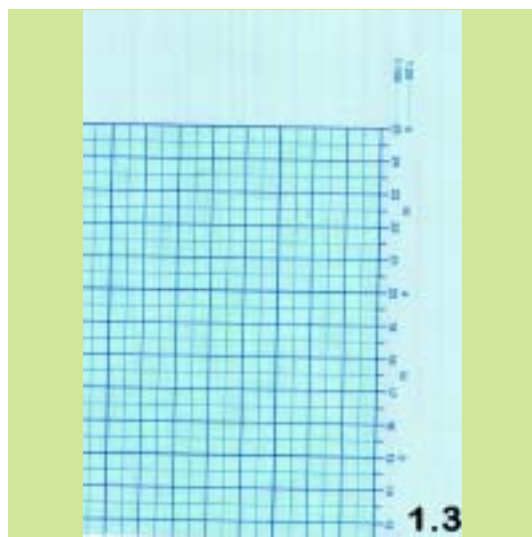

(21) Αρ. Αίτησης Σχ. ή Υπ.: 20080600155

(15) Ημερ.Καταχώρησης: 04/07/2008

(17) Ημ. Λήξης 1ης πενταετίας :4/7/2013

(71) Καταθέτης(ες): ΓΙΑΛΕΛΗΣ ΠΑΝΑΓΙΩΤΗΣ
Πίνδου 82 , Παπάγου, 15669 ΠΑΠΑΓΟΣ
(ΑΤΤΙΚΗΣ), ΕΛΛΑΔΑ

(30) Συμβ. Προτεραιότητα(ες):

(72) Δημιουργός(οι): ΓΙΑΛΕΛΗΣ ΠΑΝΑΓΙΩΤΗΣ

(74) Πληρεξούσιος:

(74) Αντίκλητος:

(28) Αριθμός Σχεδίων/Υποδειγμάτων: 4

(51) Διεθνής Ταξινόμηση: 06-06

(54) Προσδιορισμός Αντικειμένου: ΕΠΙΤΟΙΧΙΑ ΚΡΕΜΑΣΤΡΑ

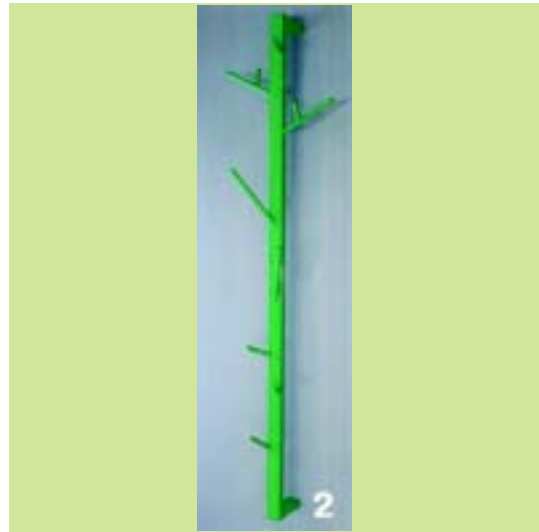

(21) *Αρ. Αίτησης Σχ. ή Υπ.*: 20080600156

(15) *Ημερ. Καταχώρησης*: 09/07/2008

(17) *Ημ. Λήξης 1ης πενταετίας*: 9/7/2013

(71) *Καταθέτης(ες)*: ΑΡΤΙΣΤΙ ΚΟΝΣΤΡΑΞΙΟΝ Α.Ε. ΚΑΤΑΣΚΕΥΗ
ΕΝΔΥΜΑΤΩΝ ΜΕ Δ.Τ. ΑΡΤΙΣΤΙ CONSTRUCTION S.A.
Βι.Πε. Αλεξανδρούπολης-Αβάντας, 68100
ΑΛΕΞΑΝΔΡΟΥΠΟΛΗ (ΕΒΡΟΥ), ΕΛΛΑΔΑ

(30) *Συμβ. Προτεραιότητα(ες)*:

(72) *Δημιουργός(οι)*: ΠΙΛΑΛΛΑΣ ΔΗΜΗΤΡΙΟΣ

(74) *Πληρεξούσιος*: ΣΙΩΤΟΥ ΑΙΚΑΤΕΡΙΝΗ
Πατησίων 122, 11257 ΑΘΗΝΑ (ΑΤΤΙΚΗΣ)

(74) *Αντίκλητος*: ΣΙΩΤΟΥ ΑΙΚΑΤΕΡΙΝΗ
Πατησίων 122, 11257 ΑΘΗΝΑ (ΑΤΤΙΚΗΣ)

(28) *Αριθμός Σχεδίων/Υποδειμάτων*: 28

(51) *Διεθνής Ταξινόμηση*: 02-07

(54) *Προσδιορισμός Αντικειμένου*: ΔΙΑΚΟΣΜΗΜΕΝΟ ΥΦΑΣΜΑ









18



21



19



22



20



23

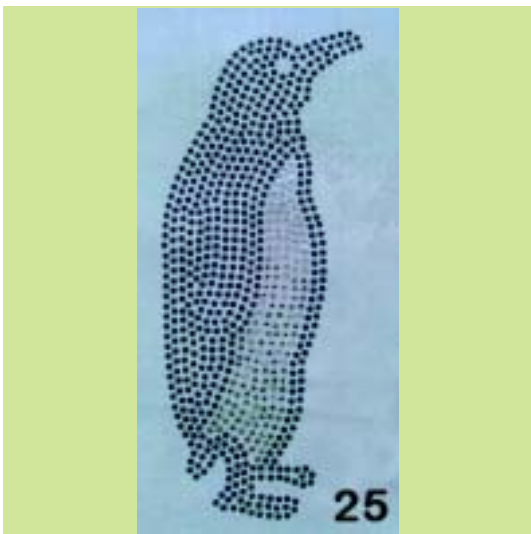

(21) *Αρ. Αίτησης Σχ. ή Υπ.:* 20080600157

(71) *Καταθέτης(ες):* ΔΗΜΑΚΟΣ ΔΗΜΗΤΡΙΟΣ
Εθνικής Αντίστασης 10, 23100 ΣΠΑΡΤΗ
(ΛΑΚΩΝΙΑΣ), ΕΛΛΑΔΑ

(45) *Ημ/νία Λήξης Αναβολής Δημοσίευσης:* 10/07/2009

(21) *Αρ. Αίτησης Σχ. ή Υπ.:* 20080600158

(15) *Ημερ. Καταχώρησης:* 16/07/2008

(17) *Ημ. Λήξης 1ης πενταετίας :* 16/7/2013

(71) *Καταθέτης(ες):* FOLLI FOLLIE ABEE
23ο χλμ Εθνικής Οδού Αθηνών-Λαμίας, 14565
ΑΓΙΟΣ ΣΤΕΦΑΝΟΣ (ΑΤΤΙΚΗΣ), ΕΛΛΑΔΑ

(30) *Συμβ. Προτεραιότητα(ες):*

(72) *Δημιουργός(οι):* ΚΟΥΤΣΟΛΙΟΥΤΣΟΣ ΔΗΜΗΤΡΙΟΣ

(74) *Πληρεξούσιος:*

(74) *Αντίκλητος:* ΑΝΑΓΝΩΣΤΟΠΟΥΛΟΥ ΒΑΣΙΛΙΚΗ
23ο χλμ Εθνικής Οδού Αθηνών-Λαμίας, 14565
ΑΓΙΟΣ ΣΤΕΦΑΝΟΣ (ΑΤΤΙΚΗΣ)

(28) *Αριθμός Σχεδίων/Υποδειγμάτων:* 23

(51) *Διεθνής Ταξινόμηση:* 10-02

(54) *Προσδιορισμός Αντικειμένου:* ΡΟΛΟΓΙΑ ΜΕ ΛΟΥΡΑΚΙ Ή ΜΠΡΑΣΕΛΕ ΔΙΑΚΟΣΜΗΜΕΝΑ ΜΕ ΗΜΙ-ΠΟΛΥΤΙΜΟΥΣ ΛΙΘΟΥΣ







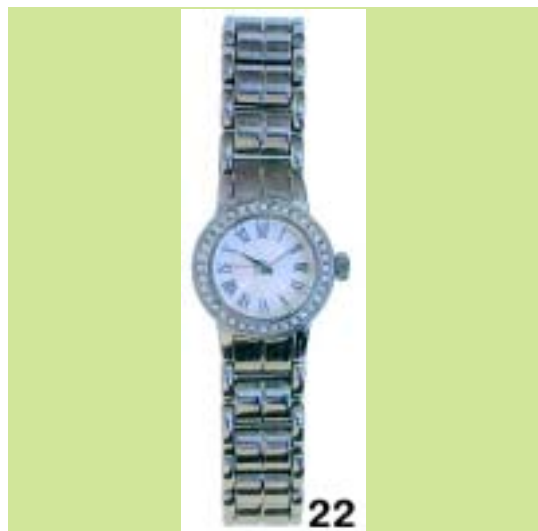



(21) Αρ. Αίτησης Σχ. ή Υπ.: 20080600159

(15) Ημερ. Καταχώρησης: 16/07/2008

(17) Ημ. Λήξης 1ης πενταετίας :16/7/2013

(71) Καταθέτης(ες): FOLLI FOLLIE ABEE
23ο χλμ Εθνικής Οδού Αθηνών-Λαμίας, 14565
ΑΓΙΟΣ ΣΤΕΦΑΝΟΣ (ΑΤΤΙΚΗΣ), ΕΛΛΑΔΑ

(30) Συμβ. Προτεραιότητα(ες):

(72) Δημιουργός(οι): ΚΟΥΤΣΟΛΙΟΥΤΣΟΣ ΔΗΜΗΤΡΙΟΣ

(74) Πληρεξούσιος:

(74) Αντίκλητος: ΑΝΑΓΝΩΣΤΟΠΟΥΛΟΥ ΒΑΣΙΛΙΚΗ
23ο χλμ Εθνικής Οδού Αθηνών-Λαμίας, 14565
ΑΓΙΟΣ ΣΤΕΦΑΝΟΣ (ΑΤΤΙΚΗΣ)

(28) Αριθμός Σχεδίων/Υποδειγμάτων: 20

(51) Διεθνής Ταξινόμηση: 10-02

(54) Προσδιορισμός Αντικειμένου: ΡΟΛΟΓΙΑ ΜΕ ΛΟΥΡΑΚΙ ΑΠΟ
ΚΑΟΥΤΣΟΥΚ Ή ΔΕΡΜΑ ΣΕ
ΔΙΑΦΟΡΑ ΧΡΩΜΑΤΑ ΚΑΙ
ΚΑΝΤΡΑΝ ΜΕ Ή ΧΩΡΙΣ ΧΡΟΝΟ-
ΓΡΑΦΟΥΣ







10



13



11



14



12



15

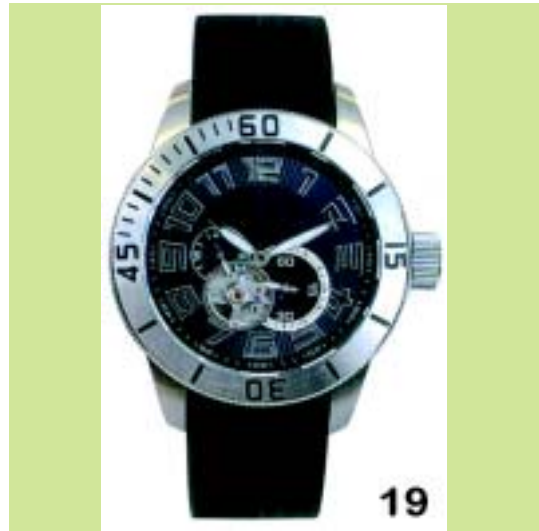

(21) *Αρ. Αίτησης Σχ. ή Υπ.*: 20080600160

(15) *Ημερ. Καταχώρησης*: 18/07/2008

(17) *Ημ. Αήξης 1ης πενταετίας*: 18/7/2013

(71) *Καταθέτης(ες)*: 1)ΣΑΡΑΝΤΙΔΟΥ ΕΛΙΣΣΑΒΕΤ
Ηρώων Πολυτεχνείου 3, 16121 ΚΑΙΣΑΡΙΑΝΗ
(ΑΤΤΙΚΗΣ), ΕΛΛΑΔΑ

(30) *Συμβ. Προτεραιότητα(ες)*:

(72) *Δημιουργός(οι)*: 1)ΣΑΡΑΝΤΙΔΟΥ ΕΛΙΣΣΑΒΕΤ

(74) *Πληρεξούσιος*: ΠΡΙΦΤΗ ΑΓΓΕΛΙΚΗ

Τσαμαδού 39, 10683 ΑΘΗΝΑ (ΑΤΤΙΚΗΣ)

(74) *Αντίκλητος*: ΠΡΙΦΤΗ ΑΓΓΕΛΙΚΗ

Τσαμαδού 39, 10683 ΑΘΗΝΑ (ΑΤΤΙΚΗΣ)

(28) *Αριθμός Σχεδίων/Υποδειγμάτων*: 50

(51) *Διεθνής Ταξινόμηση*: 11-01

(54) *Προσδιορισμός Αντικειμένου*: ΚΟΣΜΗΜΑΤΑ







12



15



13



16



14



17



18



20.1



19.1

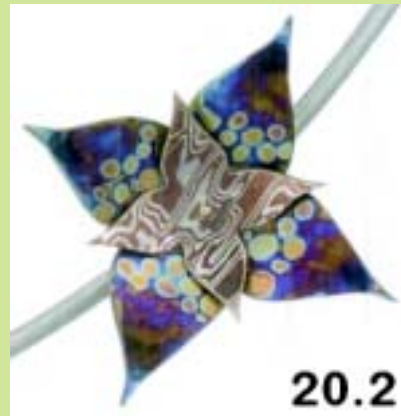

20.2



19.2



21



22



25



23



26



24



27

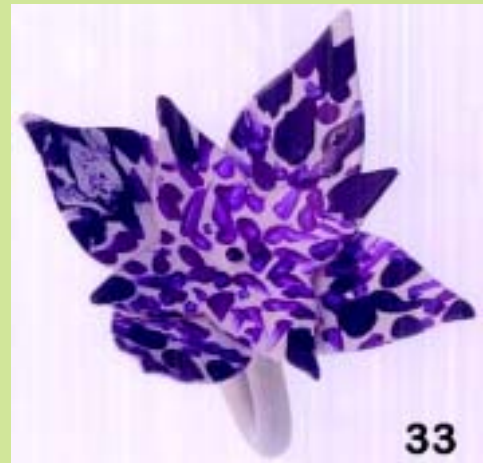



34



37



35



38



36



39

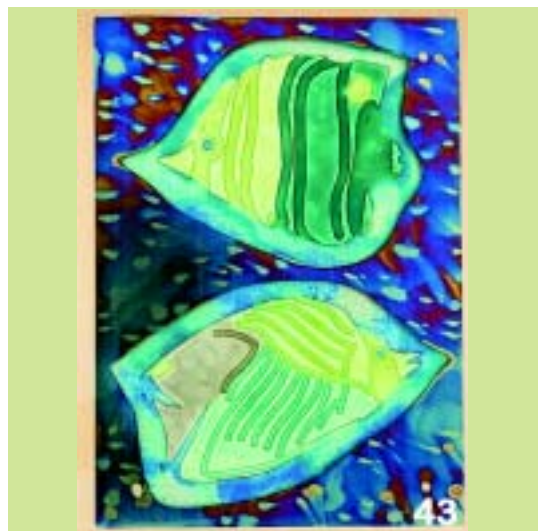

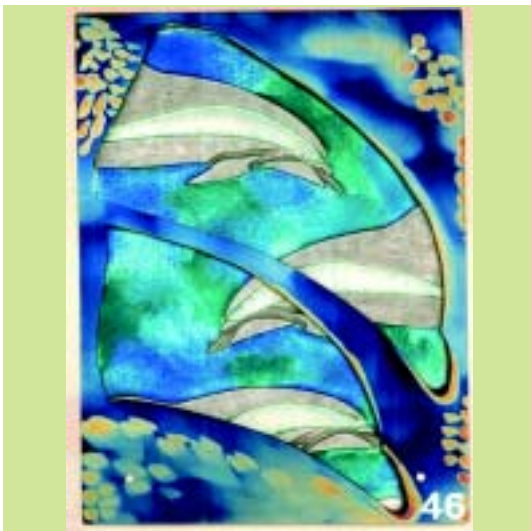



(21) Αρ. Αίτησης Σχ. ή Υπ.: 20080600161

(15) Ημερ. Καταχώρησης: 18/07/2008

(17) Ημ. Λήξης 1ης πενταετίας :18/7/2013

(71) Καταθέτης(ες): ΓΚΟΛΦΗΣ ΔΗΜΗΤΡΙΟΣ
Αίμωνος 18, 26332 ΠΑΤΡΑ (ΑΧΑΪΑΣ),
ΕΛΛΑΔΑ

(30) Συμβ. Προτεραιότητα(ες):

(72) Δημιουργός(οι): ΓΚΟΛΦΗΣ ΔΗΜΗΤΡΙΟΣ

(74) Πληρεξούσιος:

(74) Αντικλητος:

(28) Αριθμός Σχεδίων/Υποδειγμάτων: 7

(51) Διεθνής Ταξινόμηση: 12-08

(54) Προσδιορισμός Αντικειμένου: ΑΥΤΟΚΙΝΗΤΟ

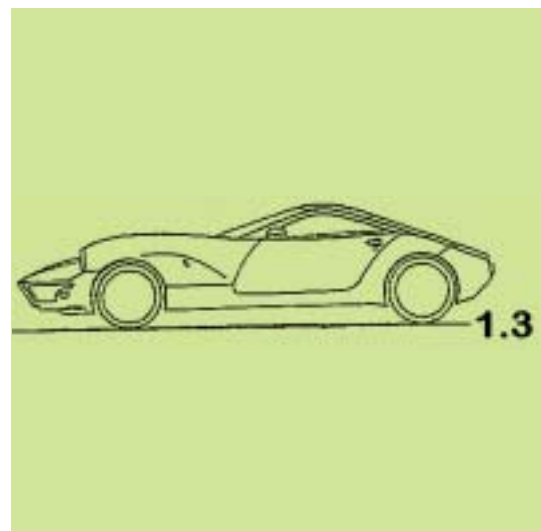
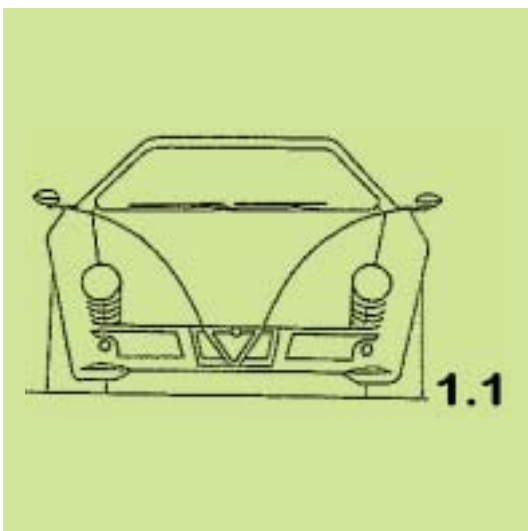
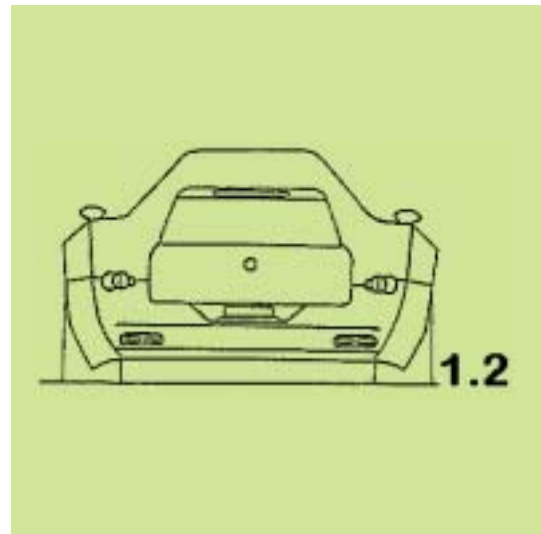

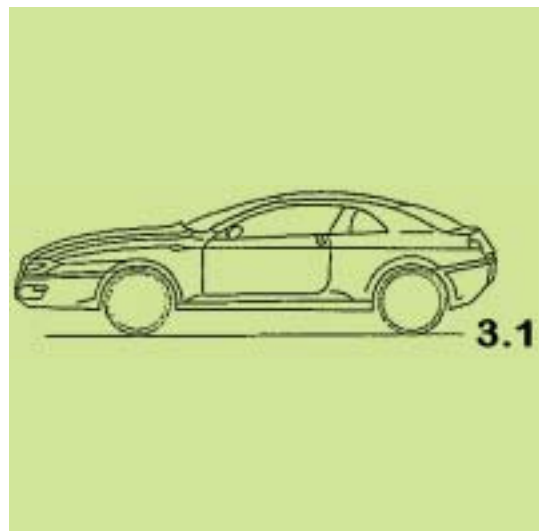
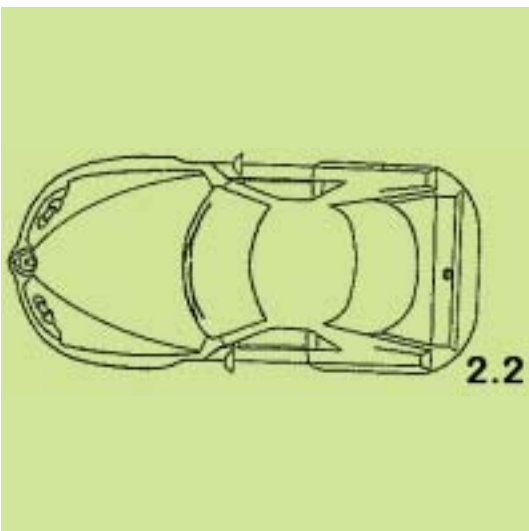
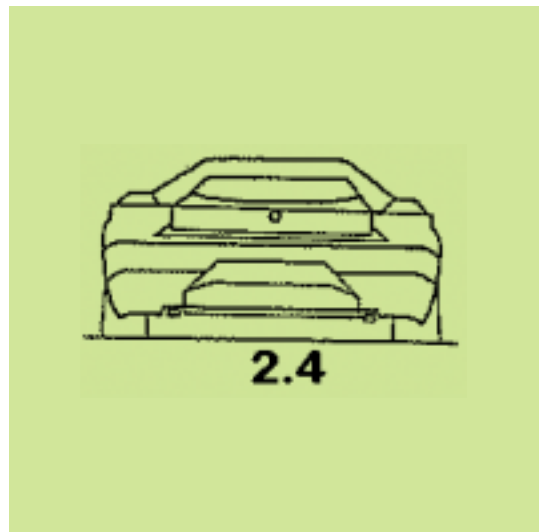
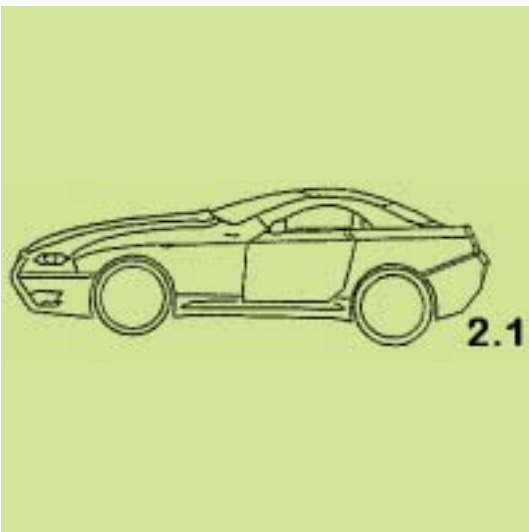
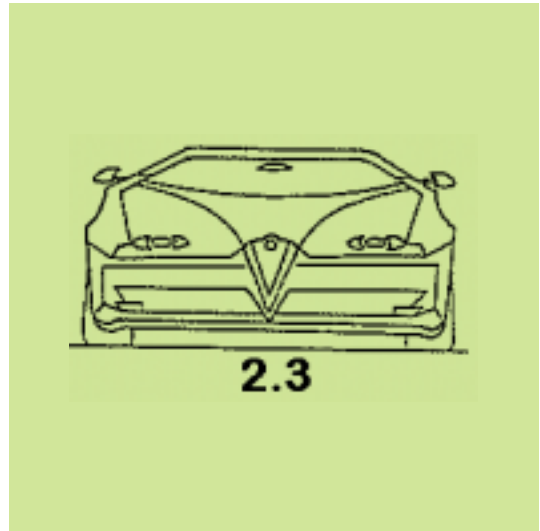
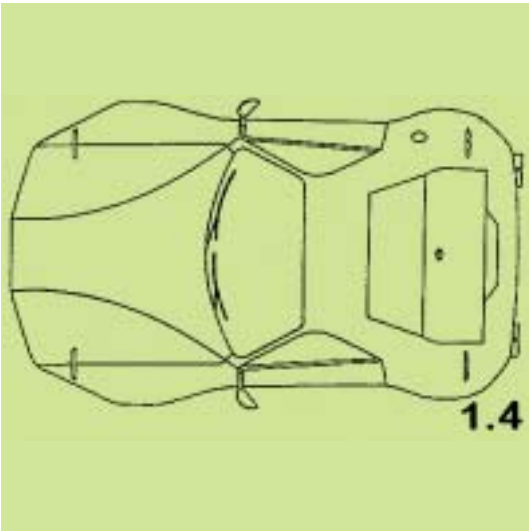

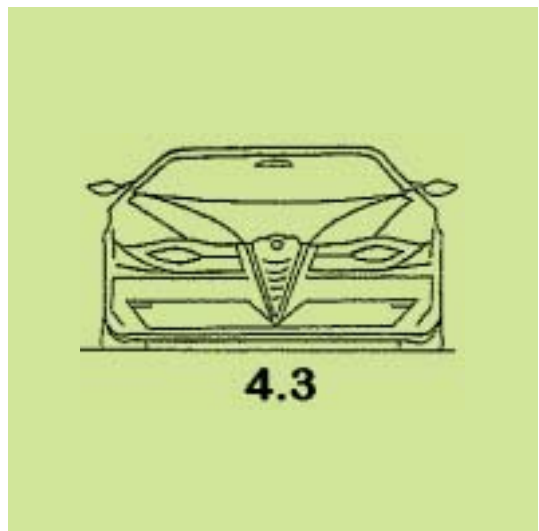
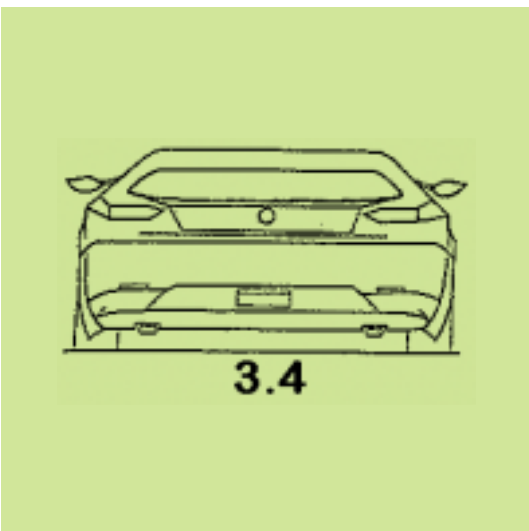
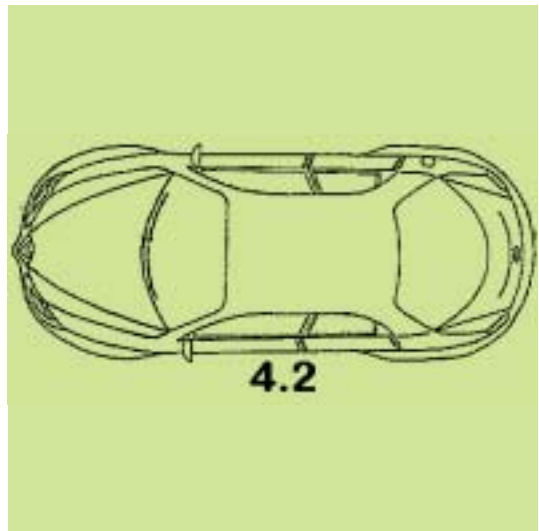
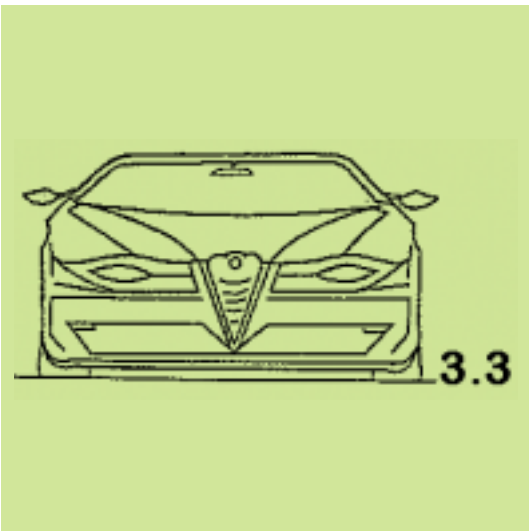
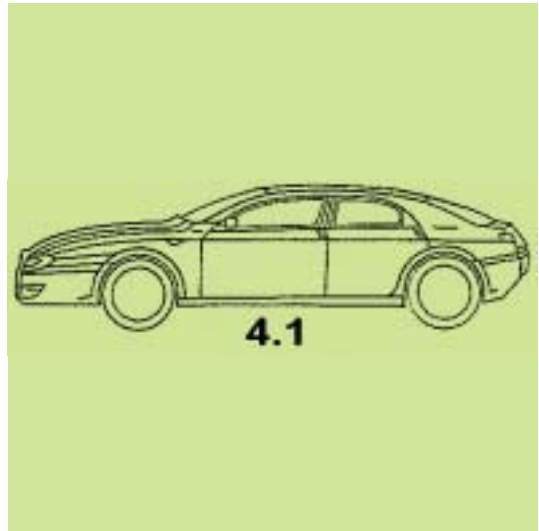
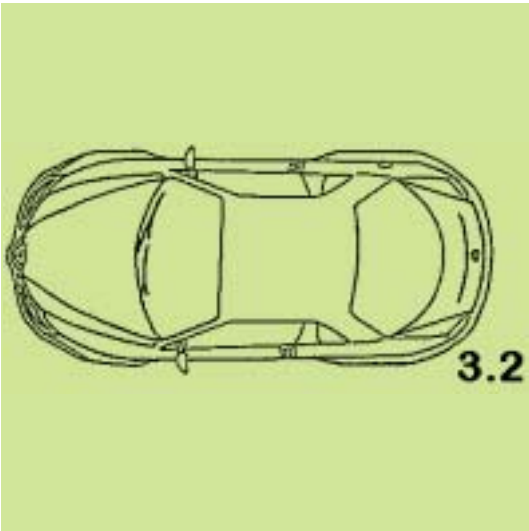

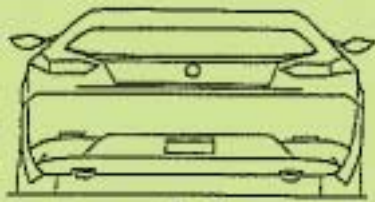

4.4

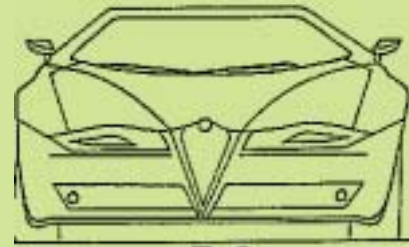

5.3



5.1

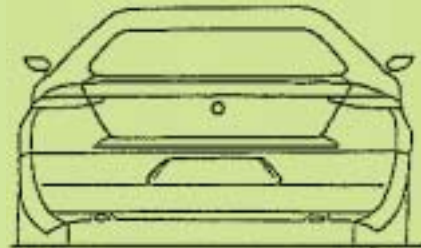

5.4

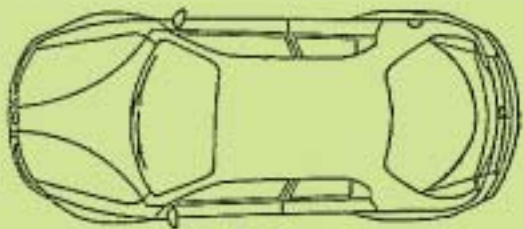

5.2



6.1

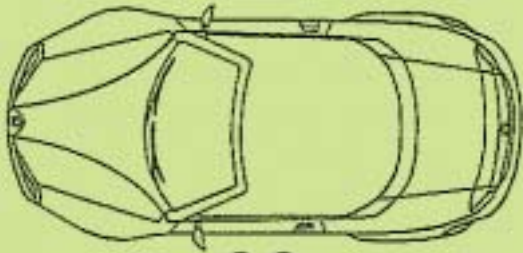

6.2

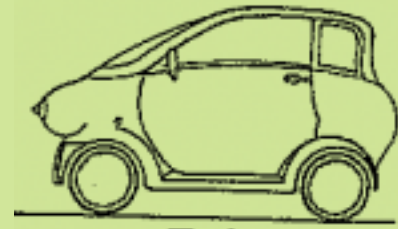

7.1

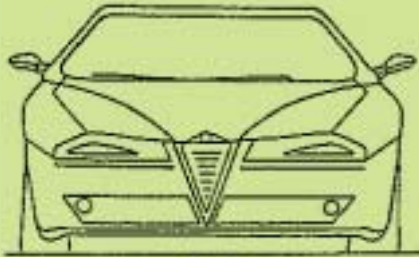

6.3

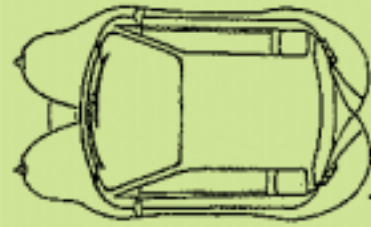

7.2



6.4



7.3

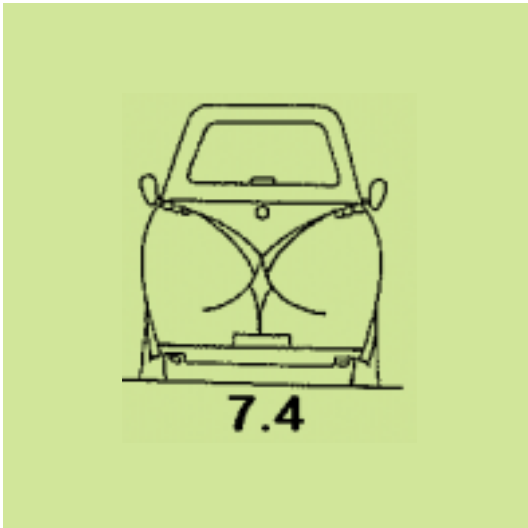

(21) **Αρ. Αίτησης Σχ. ή Υπ.: 20080600162**

(15) **Ημερ. Καταχώρησης:** 18/07/2008

(17) **Ημ. Αήξης 1ης πενταετίας :** 18/7/2013

(71) **Καταθέτης(ες):** ΓΚΟΛΦΗΣ ΔΗΜΗΤΡΙΟΣ
Αίμωνος 18, 26332 ΠΑΤΡΑ (ΑΧΑΪΑΣ),
ΕΛΛΑΔΑ

(30) **Συμβ. Προτεραιότητα(ες):**

(72) **Δημιουργός(οι):** ΓΚΟΛΦΗΣ ΔΗΜΗΤΡΙΟΣ

(74) **Πληρεξούσιος:**

(74) **Αντίκλητος:**

(28) **Αριθμός Σχεδίων/Υποδειγμάτων:** 1

(51) **Διεθνής Ταξινόμηση:** 12-16

(54) **Προσδιορισμός Αντικειμένου:** ΖΑΝΤΑ ΑΥΤΟΚΙΝΗΤΟΥ

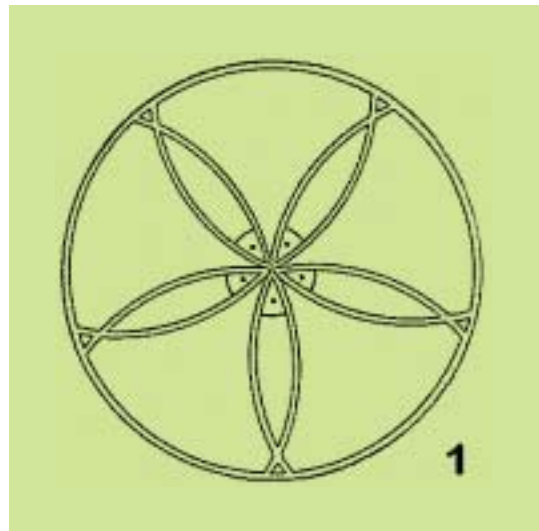

(21) **Αρ. Αίτησης Σχ. ή Υπ.: 20080600163**

(15) **Ημερ. Καταχώρησης:** 22/07/2008

(17) **Ημ. Αήξης 1ης πενταετίας :** 22/7/2013

(71) **Καταθέτης(ες):** 1) Α & Δ ΨΩΜΟΠΟΥΛΟΣ & ΣΙΑ Ε.Ε.
Ταύρου 20, 17778 ΤΑΥΡΟΣ (ΑΤΤΙΚΗΣ),
ΕΛΛΑΔΑ

(30) **Συμβ. Προτεραιότητα(ες):**

(72) **Δημιουργός(οι):** 1) ΨΩΜΟΠΟΥΛΟΣ ΔΗΜΗΤΡΗΣ

(74) **Πληρεξούσιος:**

(74) **Αντίκλητος:** ΨΩΜΟΠΟΥΛΟΣ ΑΝΤΩΝΗΣ
Προόδου 33, 16673 ΒΟΥΛΑ (ΑΤΤΙΚΗΣ)

(28) **Αριθμός Σχεδίων/Υποδειγμάτων:** 50

(51) **Διεθνής Ταξινόμηση:** 11-01

(54) **Προσδιορισμός Αντικειμένου:** ΚΟΣΜΗΜΑΤΑ ΦΟ ΜΠΙΖΟΥ ΚΑΙ
ΔΙΑΚΟΣΜΗΤΙΚΑ ΑΝΤΙΚΕΙΜΕΝΑ





























(21) *Αρ. Αίτησης Σχ. ή Υπ.:* 20080600164

(15) *Ημερ. Καταχώρησης:* 22/07/2008

(17) *Ημ. Λήξης 1ης πενταετίας :* 22/7/2013

(71) *Καταθέτης(ες):* Α & Δ ΨΩΜΟΠΟΥΛΟΣ & ΣΙΑ Ε.Ε.
Ταύρου 20, 17778 ΤΑΥΡΟΣ (ΑΤΤΙΚΗΣ),
ΕΛΛΑΔΑ

(30) *Συμβ. Προτεραιότητα(ες):*

(72) *Δημιουργός(οι):* ΨΩΜΟΠΟΥΛΟΣ ΔΗΜΗΤΡΗΣ

(74) *Πληρεξούσιος:*

(74) *Αντίκλητος:* ΨΩΜΟΠΟΥΛΟΣ ΑΝΤΩΝΗΣ
Προόδου 33, 16673 ΒΟΥΛΑ (ΑΤΤΙΚΗΣ)

(28) *Αριθμός Σχεδίων/Υποδειγμάτων:* 19

(51) *Διεθνής Ταξινόμηση:* 11-01

(54) *Προσδιορισμός Αντικειμένων:* ΚΟΣΜΗΜΑΤΑ ΦΟ'ΜΠΙΖΟΥ ΚΑΙ
ΔΙΑΚΟΣΜΗΤΙΚΑ ΑΝΤΙΚΕΙΜΕΝΑ



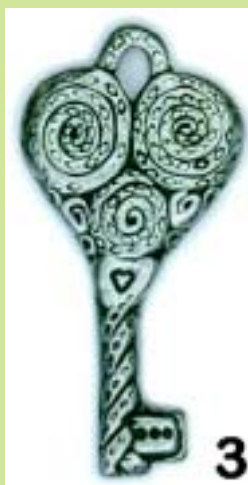





(21) *Αρ. Αίτησης Σχ. ή Υπ.*: 20080600165

(15) *Ημερ. Καταχώρησης*: 22/07/2008

(17) *Ημ. Λήξης 1ης πενταετίας*: 22/7/2013

(71) *Καταθέτης(ες)*: ΝΙΚΟΛΗΣ ΓΚΡΟΥΠΙ ΕΜΠΟΡΙΚΗ ΚΑΙ ΒΙΟΜΗΧΑΝΙΚΗ ΑΝΩΝΥΜΗ ΕΤΑΙΡΕΙΑ- ΑΞΕΣΟΥΑΡ ΜΟΔΑΣ ΚΑΙ ΔΩΡΩΝ Ποσειδώνος 38-40 και Γκιώνας 1, 14451 ΜΕΤΑΜΟΡΦΩΣΗ (ΑΤΤΙΚΗΣ), ΕΛΛΑΔΑ

(30) *Συμβ. Προτεραιότητα(ες)*:

(72) *Δημιουργός(οι)*: ΜΑΛΕΣΗ ΙΩΑΝΝΑ

(74) *Πληρεξούσιος*: ΓΕΩΡΓΙΑΔΗ ΠΟΛΥΒΙΑ
Εμ.Μπενάκη 57, 10681 ΑΘΗΝΑ (ΑΤΤΙΚΗΣ)

(74) *Αντίκλητος*: ΓΕΩΡΓΙΑΔΗ ΠΟΛΥΒΙΑ
Εμ.Μπενάκη 57, 10681 ΑΘΗΝΑ (ΑΤΤΙΚΗΣ)

(28) *Αριθμός Σχεδίων/Υποδειγμάτων*: 50

(51) *Διεθνής Ταξινόμηση*: 11-01

(54) *Προσδιορισμός Αντικειμένου*: ΚΟΣΜΗΜΑΤΑ

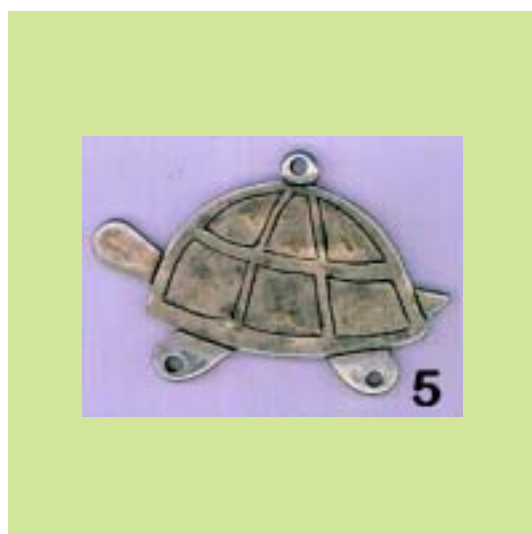



6



9



7



10



8



11











36



39



37



40



38



41





(21) *Αρ. Αίτησης Σχ. ή Υπ.:* 20080600166

(15) *Ημερ. Καταχώρησης:* 23/07/2008

(17) *Ημ. Λήξης 1ης πενταετίας :* 23/7/2013

(71) *Καταθέτης(ες):* Α. ΚΑΛΦΑΓΙΩΡΓΗΣ ΚΑΙ ΣΙΑ Ο.Ε. "ΚΑΛΦΕΞ"
14ο χλμ Α.Σπάτων, 15351 ΠΑΛΛΗΝΗ
(ΑΤΤΙΚΗΣ), ΕΛΛΑΔΑ

(30) *Συμβ. Προτεραιότητα(ες):*

(72) *Δημιουργός(οι):* ΚΑΛΦΑΓΙΩΡΓΗΣ ΑΡΙΣΤΕΙΔΗΣ

(74) *Πληρεξούσιος:* ΣΑΚΕΛΛΑΡΙΔΗ ΒΑΛΗ-ΒΑΣΙΛΙΚΗ
Αδριανού 70, 10556 ΑΘΗΝΑ (ΑΤΤΙΚΗΣ)

(74) *Αντικλητος:* ΣΑΚΕΛΛΑΡΙΔΗ ΒΑΛΗ-ΒΑΣΙΛΙΚΗ
Αδριανού 70, 10556 ΑΘΗΝΑ (ΑΤΤΙΚΗΣ)

(28) *Αριθμός Σχεδίων/Υποδειγμάτων:* 1

(51) *Διεθνής Ταξινόμηση:* 26-05

(54) *Προσδιορισμός Αντικειμένου:* ΦΩΤΙΣΤΙΚΟ ΣΩΜΑ





(21) Αρ. Αίτησης Σχ. ή Υπ.: 20080600167

(15) Ημερ. Καταχώρησης: 24/07/2008

(17) Ημ. Λήξης 1ης πενταετίας :24/7/2013

(71) Καταθέτης(ες): ΣΩΤ. ΣΜΠΟΡΑΣ ΚΑΙ ΣΙΑ Ε.Ε.
Λεούκης 22, 14231 ΝΕΑ ΙΩΝΙΑ (ΑΤΤΙΚΗΣ),
ΕΛΛΑΔΑ

(30) Συμβ. Προτεραιότητα(ες):

(72) Δημιουργός(οι): ΣΜΠΟΡΑΣ ΣΩΤΗΡΗΣ

(74) Πληρεξούσιος:

(74) Αντίκλητος:

(28) Αριθμός Σχεδίων/Υποδειγμάτων: 24

(51) Διεθνής Ταξινόμηση: 06-13

(54) Προσδιορισμός Αντικειμένου: ΣΧΕΔΙΑ ΕΜΠΡΙΜΕ ΛΕΥΚΩΝ ΕΙ-
ΔΩΝ

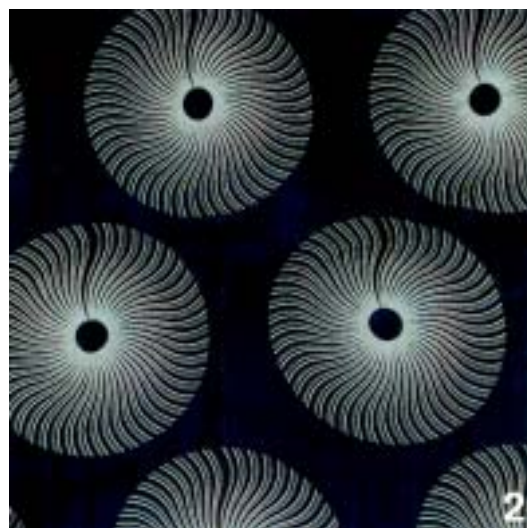

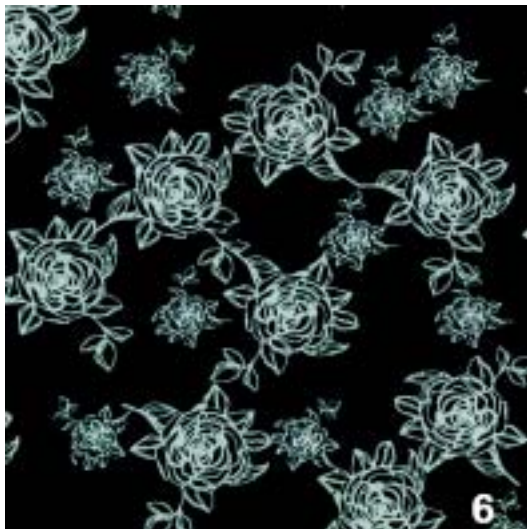

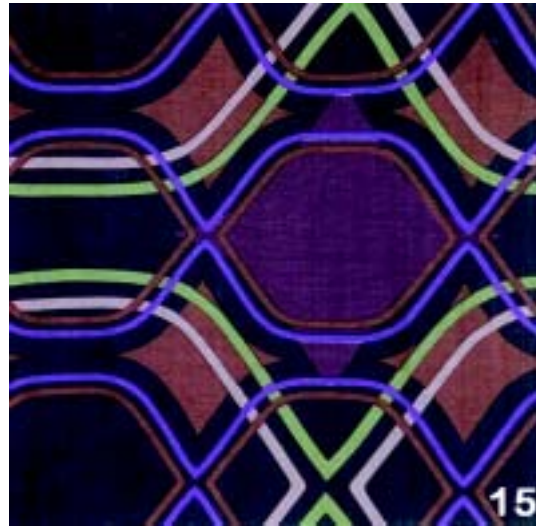
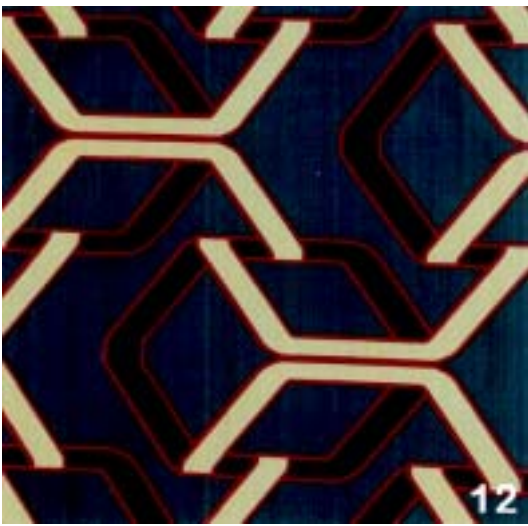
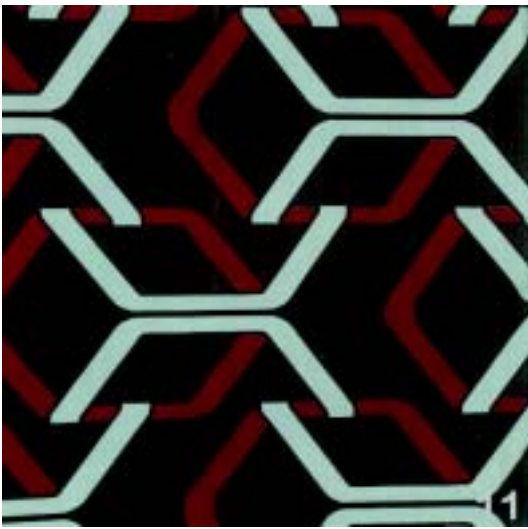
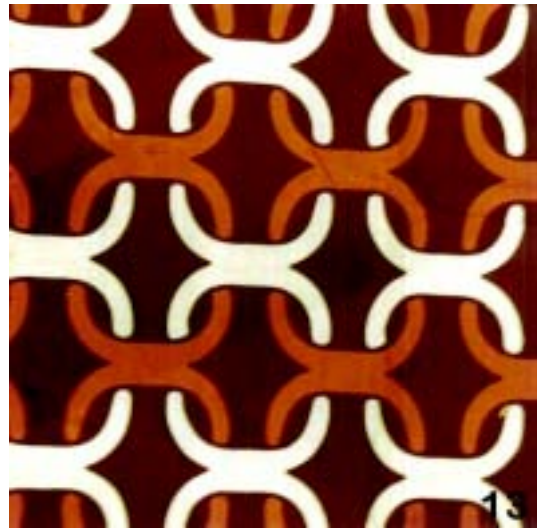

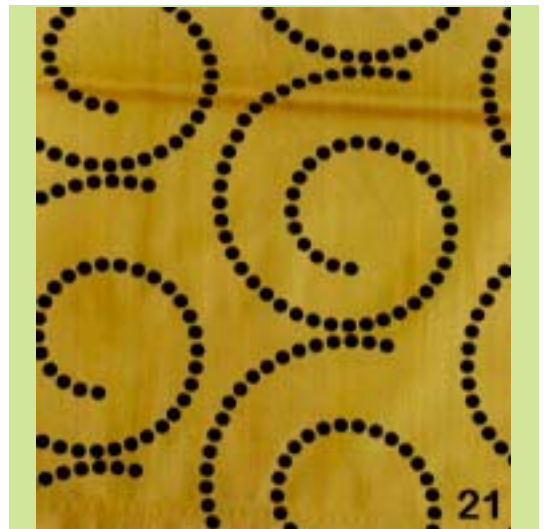
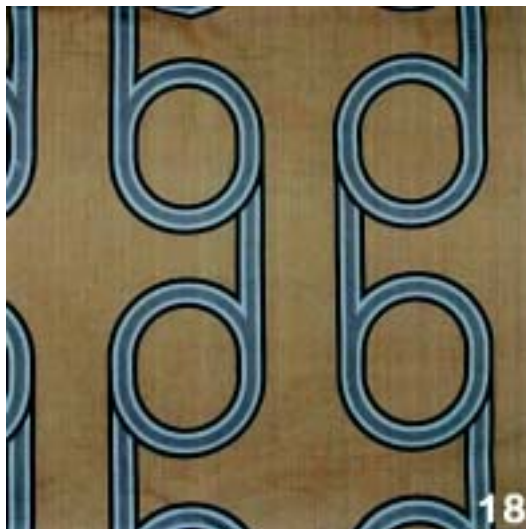
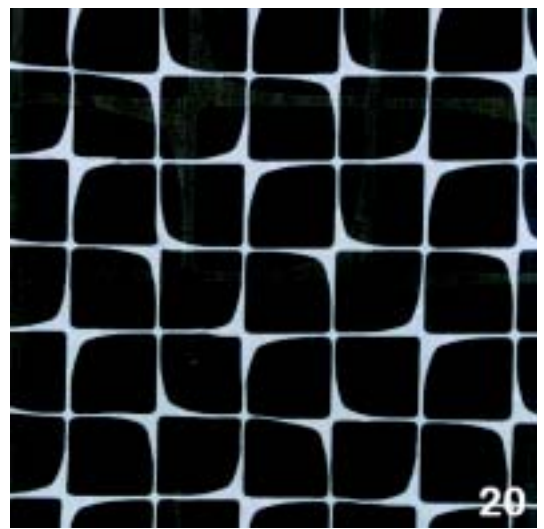
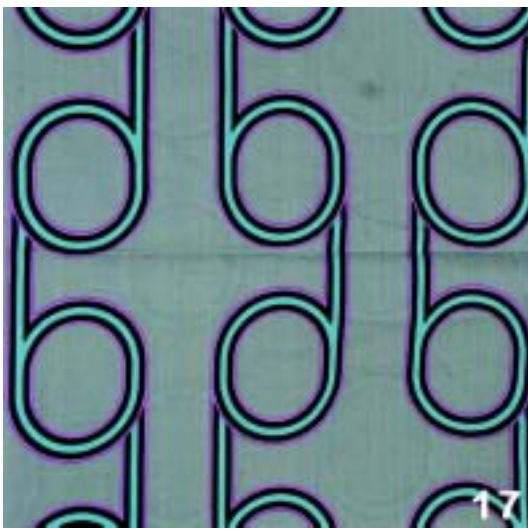
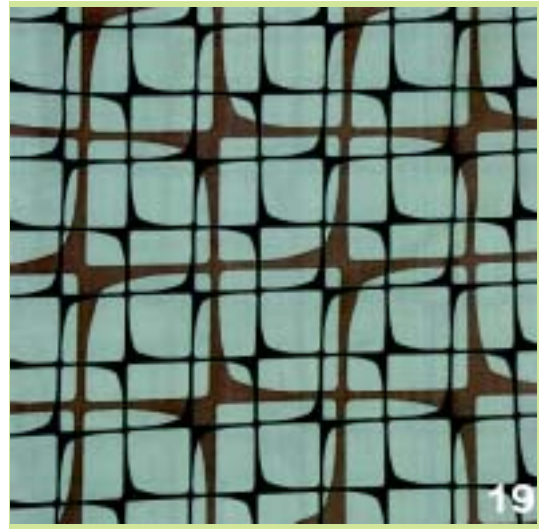
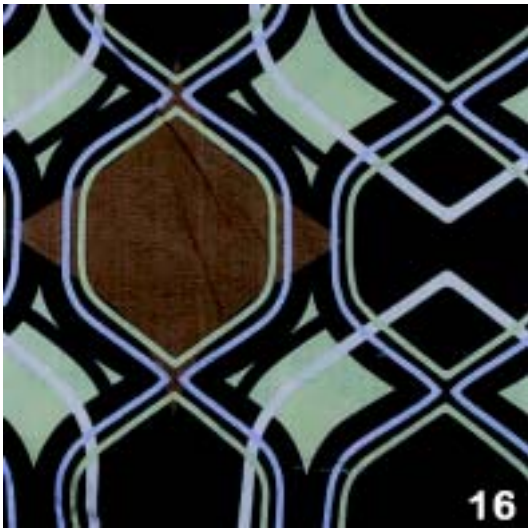

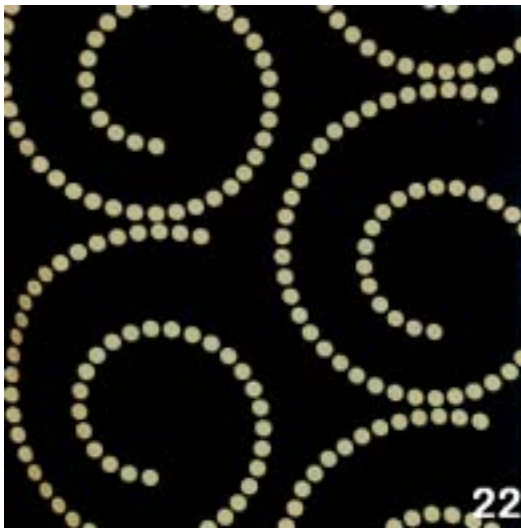

(21) Αρ. Αίτησης Σχ. ή Υπ.: 20080600168

(15) Ημερ. Καταχώρησης: 28/07/2008

(17) Ημ. Λήξης 1ης πενταετίας :28/7/2013

(71) Καταθέτης(ες): ΠΑΤΡΙΚΙΟΣ ΜΑΡΙΝΟΣ
Μαυροκορδάτου 6, 18532 ΠΕΙΡΑΙΑΣ
(ΑΤΤΙΚΗΣ), ΕΛΛΑΔΑ

(30) Συμβ. Προτεραιότητα(ες):

(72) Δημιουργός(οι): ΠΑΤΡΙΚΙΟΣ ΜΑΡΙΝΟΣ

(74) Πληρεξούσιος:

(74) Αντίκλητος: ΠΑΤΡΙΚΙΟΥ ΑΓΓΕΛΙΚΗ
Οικοδομικό Τετράγωνο 53, Οδός Πενταγίων &
Τρίτωνος, 12462 ΧΑΙΔΑΡΙ (ΑΤΤΙΚΗΣ)

(28) Αριθμός Σχεδίων/Υποδειγμάτων: 12

(51) Διεθνής Ταξινόμηση: 26-05

(54) Προσδιορισμός Αντικειμένου: ΦΩΤΙΣΤΙΚΑ ΣΩΜΑΤΑ ΕΞΩΤΕΡΙ-
ΚΟΥ ΧΩΡΟΥ



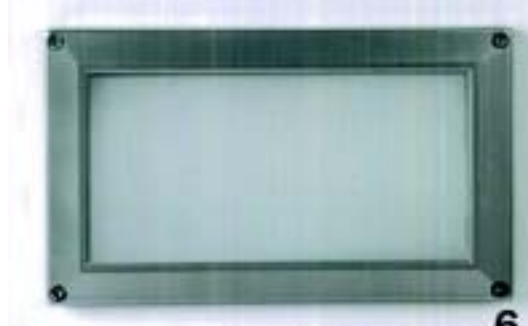
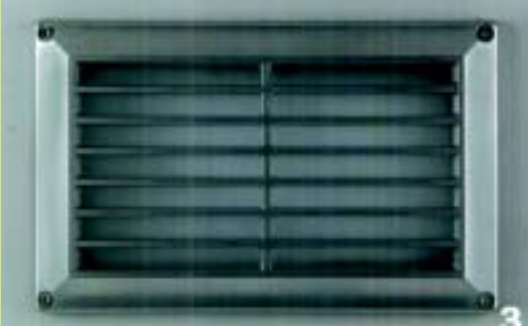

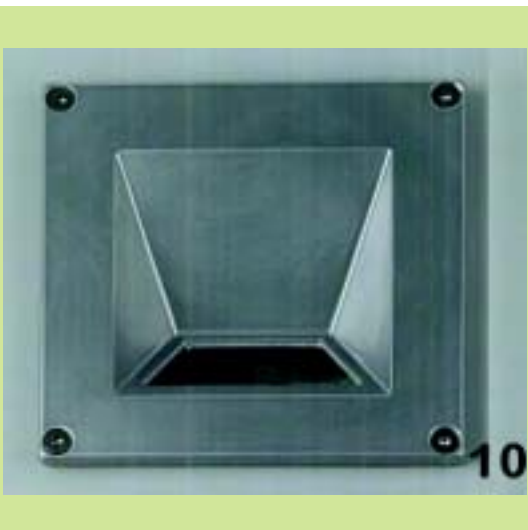
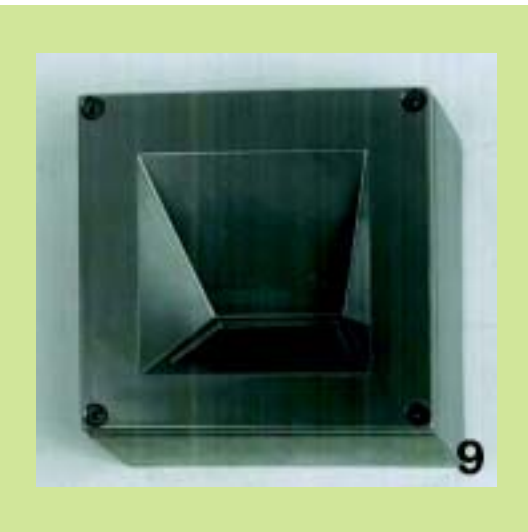

(21) *Αρ. Αίτησης Σχ. ή Υπ.*: 20080600187

(15) *Ημερ. Καταχώρησης*: 24/09/2008

(17) *Ημ. Λήξης 1ης πενταετίας*: 24/9/2013

(71) *Καταθέτης(ες)*: ΑΡΙΣΤΕΑ ΚΑΙ ΒΑΣΙΛΙΚΗ ΑΝΑΣΤΟΠΟΥΛΟΥ
Ο.Ε.
Ηλέκτρας 5, 17236 ΔΑΦΝΗ (ΑΤΤΙΚΗΣ),
ΕΛΛΑΔΑ

(30) *Συμβ. Προτεραιότητα(ες)*:

(72) *Δημιουργός(οι)*: 1)ΑΝΑΣΤΟΠΟΥΛΟΥ ΑΡΙΣΤΕΑ
2)ΑΝΑΣΤΟΠΟΥΛΟΥ ΒΑΣΙΛΙΚΗ

(74) *Πληρεξούσιος*:

(74) *Αντίκλητος*:

(28) *Αριθμός Σχεδίων/Υποδειγμάτων*: 9

(51) *Διεθνής Ταξινόμηση*: 02-04

(54) *Προσδιορισμός Αντικειμένου*: ΓΥΝΑΙΚΕΙΑ ΥΠΟΔΗΜΑΤΑ





(21) *Αρ. Αίτησης Σχ. ή Υπ.:* 20080600188

(15) *Ημερ. Καταχώρησης:* 24/09/2008

(17) *Ημ. Λήξης 1ης πενταετίας :* 24/9/2013

(71) *Καταθέτης(ες):* ΑΡΙΣΤΕΑ ΚΑΙ ΒΑΣΙΛΙΚΗ ΑΝΑΣΤΟΠΟΥΛΟΥ
Ο.Ε.
Ηλέκτρας 5, 17236 ΔΑΦΝΗ (ΑΤΤΙΚΗΣ),
ΕΛΛΑΔΑ

(30) *Συμβ. Προτεραιότητα(ες):*

(72) *Δημιουργός(οι):* 1) ΑΝΑΣΤΟΠΟΥΛΟΥ ΒΑΣΙΛΙΚΗ
2) ΑΝΑΣΤΟΠΟΥΛΟΥ ΑΡΙΣΤΕΑ

(74) *Πληρεξούσιος:*

(74) *Αντίκλητος:*

(28) *Αριθμός Σχεδίων/Υποδειγμάτων:* 5

(51) *Διεθνής Ταξινόμηση:* 02-07

(54) *Προσδιορισμός Αντικειμένων:* ΑΓΚΡΑΦΕΣ (ΑΓΚΙΣΤΡΑ) ΥΠΟΔΗ-
ΜΑΤΩΝ



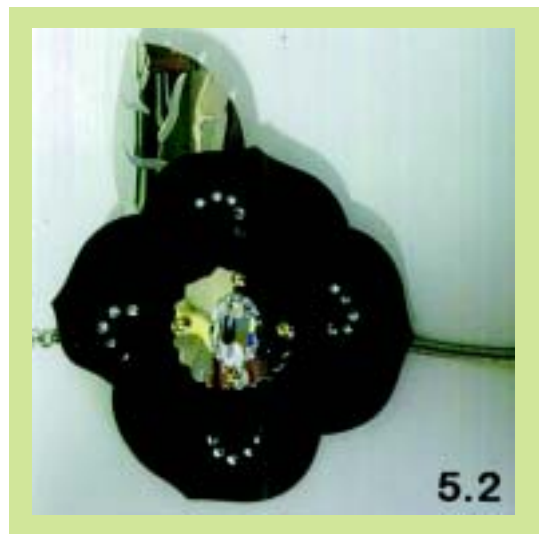

(21) *Αρ. Αίτησης Σχ. ή Υπ.*: 20080600189

(15) *Ημερ. Καταχώρησης*: 25/09/2008

(17) *Ημ. Λήξης 1ης πενταετίας*: 25/9/2013

(71) *Καταθέτης(ες)*: ΑΡΙΣΤΕΑ ΚΑΙ ΒΑΣΙΛΙΚΗ ΑΝΑΣΤΟΠΟΥΛΟΥ
Ο.Ε.
Ηλέκτρας 5, 17236 ΔΑΦΝΗ (ΑΤΤΙΚΗΣ),
ΕΛΛΑΔΑ

(30) *Συμβ. Προτεραιότητα(ες)*:

(72) *Δημιουργός(οι)*: 1) ΑΝΑΣΤΟΠΟΥΛΟΥ ΑΡΙΣΤΕΑ
2) ΑΝΑΣΤΟΠΟΥΛΟΥ ΒΑΣΙΛΙΚΗ

(74) *Πληρεξούσιος*:

(74) *Αντίκλητος*:

(28) *Αριθμός Σχεδίων/Υποδειγμάτων*: 1

(51) *Διεθνής Ταξινόμηση*: 19-08

(54) *Προσδιορισμός Αντικειμένου*: ΜΕΤΑΛΛΙΚΕΣ ΕΤΙΚΕΤΕΣ ΣΕ
ΥΠΟΔΗΜΑΤΑ



**ΕΥΡΕΤΗΡΙΟ ΑΙΤΗΣΕΩΝ ΣΧΕΔΙΩΝ Ή ΥΠΟΔΕΙΓΜΑΤΩΝ ΣΥΜΦΩΝΑ ΜΕ ΤΗΝ ΑΛΦΑΒΗΤΙΚΗ
ΣΕΙΡΑ ΤΩΝ ΚΑΤΑΘΕΤΩΝ**

ΚΑΤΑΘΕΤΗΣ (71)	ΠΡΟΣΔΙΟΡΙΣΜΟΣ ΑΝΤ/ΜΕΝΟΥ ΣΧ. Ή ΥΠ. (54)	ΚΑΤ/ΡΗΣΗ (15)	ΑΡ. ΑΙΤ. (21)
<i>FOLLI FOLLIE AΒΕΕ</i>	ΡΟΛΟΓΙΑ ΜΕ ΛΟΥΡΑΚΙ Ή ΜΠΡΑΣΕΛΕ ΔΙΑΚΟΣΜΗΜΕΝΑ ΜΕ ΗΜΠΟΛΥΤΙΜΟΥΣ ΛΙΘΟΥΣ	16/07/2008	20080600158
<i>FOLLI FOLLIE AΒΕΕ</i>	ΡΟΛΟΓΙΑ ΜΕ ΛΟΥΡΑΚΙ ΑΠΟ ΚΑΟΥΤΣΟΥΚ Ή ΔΕΡΜΑ ΣΕ ΔΙΑΦΟΡΑ ΧΡΩΜΑΤΑ ΚΑΙ ΚΑΝΤΡΑΝ ΜΕ Ή ΧΩΡΙΣ ΧΡΟΝΟΓΡΑΦΟΥΣ	16/07/2008	20080600159
<i>A & Δ ΨΩΜΟΠΟΥΛΟΣ & ΣΙΑ Ε.Ε.</i>	ΚΟΣΜΗΜΑΤΑ ΦΟ ΜΠΙΖΟΥ ΚΑΙ ΔΙΑΚΟΣΜΗΤΙΚΑ ΑΝΤΙΚΕΙΜΕΝΑ	22/07/2008	20080600163
<i>A & Δ ΨΩΜΟΠΟΥΛΟΣ & ΣΙΑ Ε.Ε.</i>	ΚΟΣΜΗΜΑΤΑ ΦΟ'ΜΠΙΖΟΥ ΚΑΙ ΔΙΑΚΟΣΜΗΤΙΚΑ ΑΝΤΙΚΕΙΜΕΝΑ	22/07/2008	20080600164
<i>A. ΚΑΛΦΑΓΙΩΡΓΗΣ ΚΑΙ ΣΙΑ Ο.Ε. "ΚΑΛΦΕΞ"</i>	ΦΩΤΙΣΤΙΚΟ ΣΩΜΑ	23/07/2008	20080600166
<i>ΑΝΤΩΝΙΟΥ ΟΔΥΣΣΕΑΣ</i>	ΣΑΚΟΥΛΕΣ ΚΑΙ ΣΑΚΟΙ ΣΥΣΚΕΥΑΣΙΑΣ ΚΑΙ ΑΠΟΡΡΙΜΜΑΤΩΝ	03/07/2008	20080600151
<i>ΑΡΙΣΤΕΑ ΚΑΙ ΒΑΣΙΛΙΚΗ ΑΝΑΣΤΟΠΟΥΛΟΥ Ο.Ε.</i>	ΓΥΝΑΙΚΕΙΑ ΥΠΟΔΗΜΑΤΑ	24/09/2008	20080600187
<i>ΑΡΙΣΤΕΑ ΚΑΙ ΒΑΣΙΛΙΚΗ ΑΝΑΣΤΟΠΟΥΛΟΥ Ο.Ε.</i>	ΑΓΚΡΑΦΕΣ (ΑΓΚΙΣΤΡΑ) ΥΠΟΔΗΜΑΤΩΝ	24/09/2008	20080600188
<i>ΑΡΙΣΤΕΑ ΚΑΙ ΒΑΣΙΛΙΚΗ ΑΝΑΣΤΟΠΟΥΛΟΥ Ο.Ε.</i>	ΜΕΤΑΛΛΙΚΕΣ ΕΤΙΚΕΤΕΣ ΣΕ ΥΠΟΔΗΜΑΤΑ	25/09/2008	20080600189
<i>ΑΡΤΙΣΤΙ ΚΟΝΣΤΡΑΣΙΟΝ Α.Ε. ΚΑΤΑΣΚΕΥΗ ΕΝΔΥΜΑΤΩΝ ΜΕ Δ.Τ. ΑΡΤΙΣΤΙ CON- STRUCTION S.A.</i>	ΔΙΑΚΟΣΜΗΜΕΝΟ ΥΦΑΣΜΑ	09/07/2008	20080600156
<i>ΓΙΑΛΕΛΗΣ ΠΑΝΑΓΙΩΤΗΣ</i>	ΕΠΙΤΟΙΧΙΑ ΚΡΕΜΑΣΤΡΑ	04/07/2008	20080600155
<i>ΓΚΟΛΦΗΣ ΔΗΜΗΤΡΙΟΣ</i>	ΑΥΤΟΚΙΝΗΤΟ	18/07/2008	20080600161
<i>ΓΚΟΛΦΗΣ ΔΗΜΗΤΡΙΟΣ</i>	ΖΑΝΤΑ ΑΥΤΟΚΙΝΗΤΟΥ	18/07/2008	20080600162
<i>ΓΥΡΙΧΙΔΗΣ ΠΑΝΑΓΙΩΤΗΣ</i>	ΦΑΚΕΛΟΣ ΑΛΛΗΛΟΓΡΑΦΙΑΣ ΜΕ ΑΠΕΙΚΟΝΙΣΗ	04/07/2008	20080600153
<i>ΓΥΡΙΧΙΔΗΣ ΠΑΝΑΓΙΩΤΗΣ</i>	ΧΑΡΤΙ ΜΙΛΙΜΕΤΡΕ	04/07/2008	20080600154
<i>ΔΑΣΚΑΛΑΚΗΣ ΚΩΝΣΤΑΝΤΙΝΟΣ</i>	ΦΩΤΙΣΤΙΚΑ ΑΠΟ ΣΙΔΕΡΟ, ΠΕΤΡΑ ΚΑΙ ΓΥΑΛΙ	23/06/2008	20080600135
<i>ΜΑΡΚΑΝΤΩΝΑΤΟΥ ΑΝΑΣΤΑΣΙΑ</i>	ΕΚΘΕΤΗΡΙΑ ΚΑΙ ΤΑΜΕΙΑ ΕΜΟΡΙΚΩΝ ΚΑΤΑΣΤΗΜΑΤΩΝ	01/07/2008	20080600145
<i>ΜΟΝΙΤΟΡ ΗΛΕΚΤΡΟΝΙΚΗ ΕΠΕ</i>	ΗΛΕΚΤΡΟΝΙΚΟΣ ΣΤΑΥΡΟΣ ΦΑΡΜΑΚΕΙΟΥ	01/07/2008	20080600152
<i>ΝΙΚΟΛΗΣ ΓΚΡΟΥΠ ΕΜΠΟΡΙΚΗ ΚΑΙ ΒΙΟΜΗΧΑΝΙΚΗ ΑΝΩΝΥΜΗ ΕΤΑΙΡΕΙΑ- ΑΞΕΣΟΥΑΡ ΜΟΔΑΣ ΚΑΙ ΔΩΡΩΝ</i>	ΚΟΣΜΗΜΑΤΑ	22/07/2008	20080600165
<i>ΟΔΥΣΣΕΑΣ ΧΑΤΖΗΒΑΣΙΛΕΙΟΥ ΚΑΙ ΣΙΑ Ε.Ε.</i>	ΡΟΛΟΓΙΑ ΧΕΙΡΟΣ	01/07/2008	20080600146
<i>ΟΔΥΣΣΕΑΣ ΧΑΤΖΗΒΑΣΙΛΕΙΟΥ ΚΑΙ ΣΙΑ Ε.Ε.</i>	ΡΟΛΟΓΙΑ ΧΕΙΡΟΣ	01/07/2008	20080600147
<i>ΟΔΥΣΣΕΑΣ ΧΑΤΖΗΒΑΣΙΛΕΙΟΥ ΚΑΙ ΣΙΑ Ε.Ε.</i>	ΡΟΛΟΓΙΑ ΧΕΙΡΟΣ	02/07/2008	20080600148
<i>ΟΔΥΣΣΕΑΣ ΧΑΤΖΗΒΑΣΙΛΕΙΟΥ ΚΑΙ ΣΙΑ Ε.Ε.</i>	ΡΟΛΟΓΙΑ ΧΕΙΡΟΣ	02/07/2008	20080600149
<i>ΠΑΤΡΙΚΙΟΣ ΜΑΡΙΝΟΣ</i>	ΦΩΤΙΣΤΙΚΑ ΣΩΜΑΤΑ ΕΞΩΤΕΡΙΚΟΥ ΧΩΡΟΥ	28/07/2008	20080600168
<i>ΣΑΡΑΝΤΙΔΟΥ ΕΛΙΣΣΑΒΕΤ</i>	ΚΟΣΜΗΜΑΤΑ	18/07/2008	20080600160

ΚΑΤΑΘΕΤΗΣ (71)	ΠΡΟΣΔΙΟΡΙΣΜΟΣ ΑΝΤ/ΜΕΝΟΥ ΣΧ. Ή ΥΠ. (54)	ΚΑΤ/ΡΗΣΗ (15)	ΑΡ. ΑΙΤ. (21)
<i>ΣΥΠΟ Ε.Π.Ε. ΕΤΑΙΡΕΙΑ ΠΕΡΙΟΡΙΣΜΕΝΗΣ ΕΥΘΥΝΗΣ</i>	ΠΟΜΟΛΑ	01/07/2008	20080600144
<i>ΣΩΤ. ΣΜΠΟΡΑΣ ΚΑΙ ΣΙΑ Ε.Ε.</i>	ΣΧΕΔΙΑ ΕΜΠΡΙΜΕ ΛΕΥΚΩΝ ΕΙΔΩΝ	24/07/2008	20080600167

ΜΕΡΟΣ Β'
ΚΑΤΑΧΩΡΗΜΕΝΑ ΠΙΣΤΟΠΟΙΗΤΙΚΑ ΣΧΕΔΙΩΝ ΚΑΙ ΥΠΟΔΕΙΓΜΑΤΩΝ

ΧΟΡΗΓΗΣΕΙΣ ΠΙΣΤΟΠΟΙΗΤΙΚΩΝ ΚΑΤΑΧΩΡΗΣΗΣ ΣΧΕΔΙΩΝ ΚΑΙ ΥΠΟΔΕΙΓΜΑΤΩΝ

ΟΥΔΕΜΙΑ

ΔΕΝ ΥΠΑΡΧΕΙ ΔΗΜΟΣΙΕΥΣΗ

Μ Ε Ρ Ο Σ Γ '
ΑΝΑΝΕΩΣΕΙΣ

ΑΝΑΝΕΩΣΕΙΣ ΚΑΤΑΧΩΡΗΜΕΝΩΝ ΣΧΕΔΙΩΝ Ή ΥΠΟΔΕΙΓΜΑΤΩΝ

(11) Αρ. Πιστοπ. Καταχώρησης Σχ. ή Υπ.:6000222

(73) Δικαιούχος (οι): ΠΑΠΑΠΟΣΤΟΛΟΥ ΕΛΛΗ-ΚΥΡΙΑΚΗ, Εβανς 19 Τ.Θ. 30679, 10033 ΑΘΗΝΑ (GR) .
(17) Ημερομηνία Ανανέωσης: 10-6-2013 (3η 5ετία)

(11) Αρ. Πιστοπ. Καταχώρησης Σχ. ή Υπ.:6000341

(73) Δικαιούχος (οι): ΜΗΝΑΣ ΓΕΩΡΓΙΟΣ & ΣΙΑ Ο.Ε. , ΝΕΑ ΤΙΡΥΝΘΑ ΝΑΥΠΛΙΟΥ, 211 00 ΑΡΓΟΛΙΔΑ (GR) .
(17) Ημερομηνία Ανανέωσης: 4-11-2013 (3η 5ετία)

(11) Αρ. Πιστοπ. Καταχώρησης Σχ. ή Υπ.:6000385

(73) Δικαιούχος (οι): ΑΠΟΚΟΤΟΣ ΑΘΑΝΑΣΙΟΥ ΒΑΣΙΛΕΙΟΣ , Ιωνίας 86, ΝΙΚΑΙΑ, 184 50 ΠΕΙΡΑΙΑΣ (GR) .
(17) Ημερομηνία Ανανέωσης: 17-12-2013 (3η 5ετία)

(11) Αρ. Πιστοπ. Καταχώρησης Σχ. ή Υπ.:6000387

(73) Δικαιούχος (οι): ΙΩΑΝΝΟΥ ΧΑΡΑΛΑΜΠΟΣ , Ιωνίας 45, Κ. ΤΟΥΜΠΑ, 544 53 ΘΕΣΣΑΛΟΝΙΚΗ (GR) .
(17) Ημερομηνία Ανανέωσης: 17-12-2013 (3η 5ετία)

(11) Αρ. Πιστοπ. Καταχώρησης Σχ. ή Υπ.:6000394

(73) Δικαιούχος (οι): HERMAN MILLER, INC., 855 East Main Avenue, ZEELAND, 49464-0302 MICHIGAN (US) .
(17) Ημερομηνία Ανανέωσης: 4-12-2013 (3η 5ετία)

(11) Αρ. Πιστοπ. Καταχώρησης Σχ. ή Υπ.:6000395

(73) Δικαιούχος (οι): DADE BEHRING INC., 1717 Deerfield Road, PO Box 778, DEERFIELD, 60015-0778 ILLINOIS (US) .
(17) Ημερομηνία Ανανέωσης: 23-12-2013 (3η 5ετία)

(11) Αρ. Πιστοπ. Καταχώρησης Σχ. ή Υπ.:6000402

(73) Δικαιούχος (οι): ΓΙΩΤΗΣ Α.Ε. ΒΙΟΜΗΧΑΝΙΑ ΘΡΕΠΤΙΚΩΝ ΠΡΟΙΟΝΤΩΝ , Λ.Κηφισού 46-48, 10442 ΑΘΗΝΑ (ΑΤΤΙΚΗΣ) (GR) .
(17) Ημερομηνία Ανανέωσης: 23-12-2013 (3η 5ετία)

(11) Αρ. Πιστοπ. Καταχώρησης Σχ. ή Υπ.:6000416

(73) Δικαιούχος (οι): ΒΟΥΓΙΟΥΚΑ ΑΝΑΣΤΑΣΙΑ , Αμοργού 8, 553 37 ΘΕΣΣΑΛΟΝΙΚΗ (GR) .
(17) Ημερομηνία Ανανέωσης: 24-6-2013 (3η 5ετία)

(11) Αρ. Πιστοπ. Καταχώρησης Σχ. ή Υπ.:6001798

(73) Δικαιούχος (οι): ΒΛΙΩΡΑ-ΒΛΑΧΟΝΑΤΣΙΟΥ ΕΥΑΓΓΕΛΟΣ ΑΙΚΑΤΕΡΙΝΗ, Κωλέττη 9, 38334 ΒΟΛΟΣ (ΜΑΓΝΗΣΙΑΣ) (GR) .
(17) Ημερομηνία Ανανέωσης: 18-12-2013 (2η 5ετία)

(11) Αρ. Πιστοπ. Καταχώρησης Σχ. ή Υπ.:6001803

(73) Δικαιούχος (οι): ΠΑΝΤΕΛΟΣ ΑΡΙΣΤΕΙΔΗ ΠΑΝΤΕΛΗΣ, 2ο χλμ Κιμμερίων Πηγαδίων Ξάνθης, 671 00 ΞΑΝΘΗ (GR) .
(17) Ημερομηνία Ανανέωσης: 5-12-2013 (2η 5ετία)

(11) Αρ. Πιστοπ. Καταχώρησης Σχ. ή Υπ.:6001804

(73) Δικαιούχος (οι): ΠΑΝΤΕΛΟΣ ΑΡΙΣΤΕΙΔΗ ΠΑΝΤΕΛΗΣ, 2ο χλμ Κιμμερίων Πηγαδίων Ξάνθης, 671 00 ΞΑΝΘΗ (GR) .
(17) Ημερομηνία Ανανέωσης: 5-12-2013 (2η 5ετία)

(11) Αρ. Πιστοπ. Καταχώρησης Σχ. ή Υπ.:6001807

(73) Δικαιούχος (οι): ΥΠΙΟΑ AGROINDUSTRIAL LTDA , Avenida Washington Soares, 1280, Messejana,, 60811-341 FORTALEZA CEARA (BR) .
(17) Ημερομηνία Ανανέωσης: 10-12-2013 (2η 5ετία)

(11) Αρ. Πιστοπ. Καταχώρησης Σχ. ή Υπ.:6001808

(73) Δικαιούχος (οι): ΥΠΙΟΑ AGROINDUSTRIAL LTDA , Avenida Washington Soares, 1280, Messejana,, 60811-341 FORTALEZA CEARA (BR) .
(17) Ημερομηνία Ανανέωσης: 10-12-2013 (2η 5ετία)

(11) Αρ. Πιστοπ. Καταχώρησης Σχ. ή Υπ.:6001809

(73) Δικαιούχος (οι):

Υ - NOT PLASTIC ΕΠΕ , ΒΙΠΑ Μαρκοπούλου, Θέση Ντοροβατέζα, 19003 ΜΑΡΚΟΠΟΥΛΟ (ΑΤΤΙΚΗΣ) (GR) .

(17) Ημερομηνία Ανανέωσης:

12-12-2013 (2η 5ετία)

(11) Αρ. Πιστοπ. Καταχώρησης Σχ. ή Υπ.:6001846

(73) Δικαιούχος (οι):

"ΚΡΑΦΤ ΦΟΥΝΤΣ ΕΛΛΑΣ ΑΝΩΝΥΜΗ ΕΤΑΙΡΕΙΑ" με δ.τ. "KRAFT FOODS HELLAS S.A." , Γκινωσάτη 19, 144 52
ΜΕΤΑΜΟΡΦΩΣΗ ΑΤΤΙΚΗΣ (GR) .

(17) Ημερομηνία Ανανέωσης:

30-3-2014 (2η 5ετία)

ΜΕΡΟΣ Δ'
ΜΕΤΑΒΟΛΕΣ

ΠΙΣΤΟΠΟΙΗΤΙΚΑ ΚΑΤΑΧΩΡΗΣΗΣ ΣΧΕΔΙΩΝ Ή ΥΠΟΔΕΙΓΜΑΤΩΝ

ΑΡ. ΣΧ. Ή ΥΠΟΔ.	ΑΛΛΑΓΗ ΕΠΩΝΥΜΙΑΣ
6000128	Η εταιρεία “Ανώνυμος Βιομηχανική και Εμπορική Εταιρεία Ανδρικών και Γυναικείων Καλσόν - Γυναικείων Εσφορούχων – Νημάτων - Μηχανημάτων Brothers Ανώνυμη Εταιρεία» με δ.τ. «BROTHERS A.E.» δικαιούχος του υπ’ αριθμ. 6000128 πιστοποιητικού καταχώρησης σχεδίου ή υποδείγματος μετέβαλε την επωνυμία της σε: “APPLE BOXER Βιομηχανία Εσφορούχων, Καλτσών, Υφασμάτων και Ειδών Ένδυσης και Υπόδεσης Ανώνυμη Βιομηχανική και Εμπορική Εταιρεία” με δ.τ. «APPLE BOXER A.E.B.E.»
6000236	Η εταιρεία “Ανώνυμος Βιομηχανική και Εμπορική Εταιρεία Ανδρικών και Γυναικείων Καλσόν - Γυναικείων Εσφορούχων – Νημάτων - Μηχανημάτων Brothers Ανώνυμη Εταιρεία» με δ.τ. «BROTHERS A.E.» δικαιούχος του υπ’ αριθμ. 6000236 πιστοποιητικού καταχώρησης σχεδίου ή υποδείγματος μετέβαλε την επωνυμία της σε: “APPLE BOXER Βιομηχανία Εσφορούχων, Καλτσών, Υφασμάτων και Ειδών Ένδυσης και Υπόδεσης Ανώνυμη Βιομηχανική και Εμπορική Εταιρεία” με δ.τ. «APPLE BOXER A.E.B.E.»
ΑΡ. ΣΧ. Ή ΥΠΟΔ.	ΑΛΛΑΓΗ ΕΔΡΑΣ
6001809	Η εταιρεία «Υ – NOT Plastic Ε.Π.Ε.» δικαιούχος του υπ’ αριθμ. 6001809 πιστοποιητικού καταχώρησης σχεδίου ή υποδείγματος άλλαξε την έδρά της από : 25ο χλμ. Λεωφ. Λαυρίου, 194 00 Κορωπί Αττικής σε : ΒΙΠΑ Μαρκοπούλου, Θέση Ντοροβατέζα 190 03 Μαρκόπουλο Αττικής.

Μ Ε Ρ Ο Σ Ε '
ΛΗΞΗ ΠΡΟΣΤΑΣΙΑΣ

ΛΗΞΗ ΠΡΟΣΤΑΣΙΑΣ ΚΑΤΑΧΩΡΗΜΕΝΩΝ ΣΧΕΔΙΩΝ Ή ΥΠΟΔΕΙΓΜΑΤΩΝ

(11) Αρ. Πιστοπ. Καταχώρησης Σχ. ή Υπ.:6000219

(73) Δικαιούχος (οι): ΖΑΧΑΡΙΑ συζ.ΕΛΕΥΘΕΡΙΟΥ ΕΛΕΝΗ , Υψηλάντου 160, ΠΑΣΣΑΛΙΜΑΝΙ, 185 34 ΠΕΙΡΑΙΑΣ (GR) .

(11) Αρ. Πιστοπ. Καταχώρησης Σχ. ή Υπ.:6000229

(73) Δικαιούχος (οι): COLGATE-PALMOLIVE COMPANY , 300 Park Avenue, NEW YORK, 10022 NY (US) .

(11) Αρ. Πιστοπ. Καταχώρησης Σχ. ή Υπ.:6000230

(73) Δικαιούχος (οι): COLGATE-PALMOLIVE COMPANY , 300 Park Avenue, NEW YORK, 10022 NY (US) .

(11) Αρ. Πιστοπ. Καταχώρησης Σχ. ή Υπ.:6000239

(73) Δικαιούχος (οι):
1) ΔΗΜ. ΧΟΥΡΓΙΟΓΛΟΥ Ε.Π.Ε. , Ηροδότου 26, 106 75 ΑΘΗΝΑ (GR) .
2) ΧΟΥΡΣΟΓΛΟΥ ΔΗΜΟΣΘΕΝΗ ΙΩΑΚΕΙΜ-ΚΙΜΩΝ , Ηροδότου 26, 106 75 ΑΘΗΝΑ (GR) .

(11) Αρ. Πιστοπ. Καταχώρησης Σχ. ή Υπ.:6000240

(73) Δικαιούχος (οι): MARS U.K. LIMITED , 3D Dundee Road, SL1 4LG SLOUGH BERKSHIRE (GB) .

(11) Αρ. Πιστοπ. Καταχώρησης Σχ. ή Υπ.:6000242

(73) Δικαιούχος (οι): N.V. MASTERFOODS S.A. , Boulevard du Souverain 100, B7 1170 Brussel (BE) .

(11) Αρ. Πιστοπ. Καταχώρησης Σχ. ή Υπ.:6001727

(73) Δικαιούχος (οι): ΚΟΣΜΗΜΑΤΟΠΟΙΑ ΖΟΛΩΤΑΣ Α.Ε. , Καλλιρρόης 26, 117 43 ΑΘΗΝΑ (GR) .

(11) Αρ. Πιστοπ. Καταχώρησης Σχ. ή Υπ.:6001728

(73) Δικαιούχος (οι): ΠΡΟΒΑΤΑΣ ΑΔΑΜ, Οδός Ξάνθου 31Α, 15451 ΝΕΟ ΨΥΧΙΚΟ (ΑΤΤΙΚΗΣ) (GR) .

(11) Αρ. Πιστοπ. Καταχώρησης Σχ. ή Υπ.:6001731

(73) Δικαιούχος (οι): ΖΑΦΕΙΡΑΚΗ ΟΛΓΑ, Ιθάκης 28, 16561 ΓΛΥΦΑΔΑ (ΑΤΤΙΚΗΣ) (GR) .

(11) Αρ. Πιστοπ. Καταχώρησης Σχ. ή Υπ.:6001732

(73) Δικαιούχος (οι): ΑΝΤΩΝΑΚΗΣ ΡΗΓΑΣ, Αρκαδίου 214, 74100 ΡΕΘΥΜΝΟ (ΡΕΘΥΜΝΗΣ) (GR) .

ΜΕΡΟΣ ΣΤ'
ΑΚΥΡΩΣΕΙΣ

ΟΥΔΕΜΙΑ

ΣΥΝΔΡΟΜΕΣ ΓΙΑ ΤΟ ΕΔΒΙ

α) Σε οπτικό δίσκο (CD), ως εξής:		
Τεύχη Α' και Β' μαζί ανά δίσκο	EΥΡΩ	2,00
Ετήσια συνδρομή Εσωτερικού για τα Τεύχη Α' και Β' μαζί.....	EΥΡΩ	22,00
Ετήσια συνδρομή Εξωτερικού για τα Τεύχη Α' και Β' μαζί.....	EΥΡΩ	44,00
β) Ετήσια συνδρομή για τα Τεύχη Α' και Β' μαζί σε έντυπη μορφή και σε οπτικό δίσκο (CD) ταυτόχρονα.....		
Ετήσια συνδρομή Εσωτερικού	EΥΡΩ	77,00
Ετήσια συνδρομή Εξωτερικού	EΥΡΩ	154,00
γ) Ετήσια συνδρομή για την πρόσβαση και στα δύο Τεύχη του ΕΔΒΙ στις ιστοσελίδες του ΟΒΙ.....	EΥΡΩ	0,00

Κάθε ενδιαφερόμενος μπορεί να προμηθεύεται το ΕΔΒΙ ή να ζητήσει να γίνει συνδρομητής από τον:

Οργανισμό Βιομηχανικής Ιδιοκτησίας (ΟΒΙ)
Παντανάσσης 5
151 25 Παράδεισος Αμαρουσίου
τηλ.: 2106828231

SUBSCRIPTIONS FOR THE INDUSTRIAL PROPERTY BULLETIN

a) On compact disc (CD):		
Volume A' and B', price per disc	EURO	2,00
Annual domestic subscription for both Volumes (A' and B')	EURO	22,00
Annual foreign subscription for both Volumes (A' and B')	EURO	44,00
b) Annual subscription for both Volumes (A' and B') in printed form and on compact disc (CD) simultaneously		
Annual domestic subscription	EURO	77,00
Annual foreign subscription	EURO	154,00
c) Annual subscription for access to both Volumes (A' and B') displayed on the OBI's website pages.....	EURO	0,00

For bulletin purchasing or subscription information, please contact:

5 Pandanassis Str.
151 25 Paradissos Amarousiou
Athens - Greece
tel.: (0030210) 6828231